

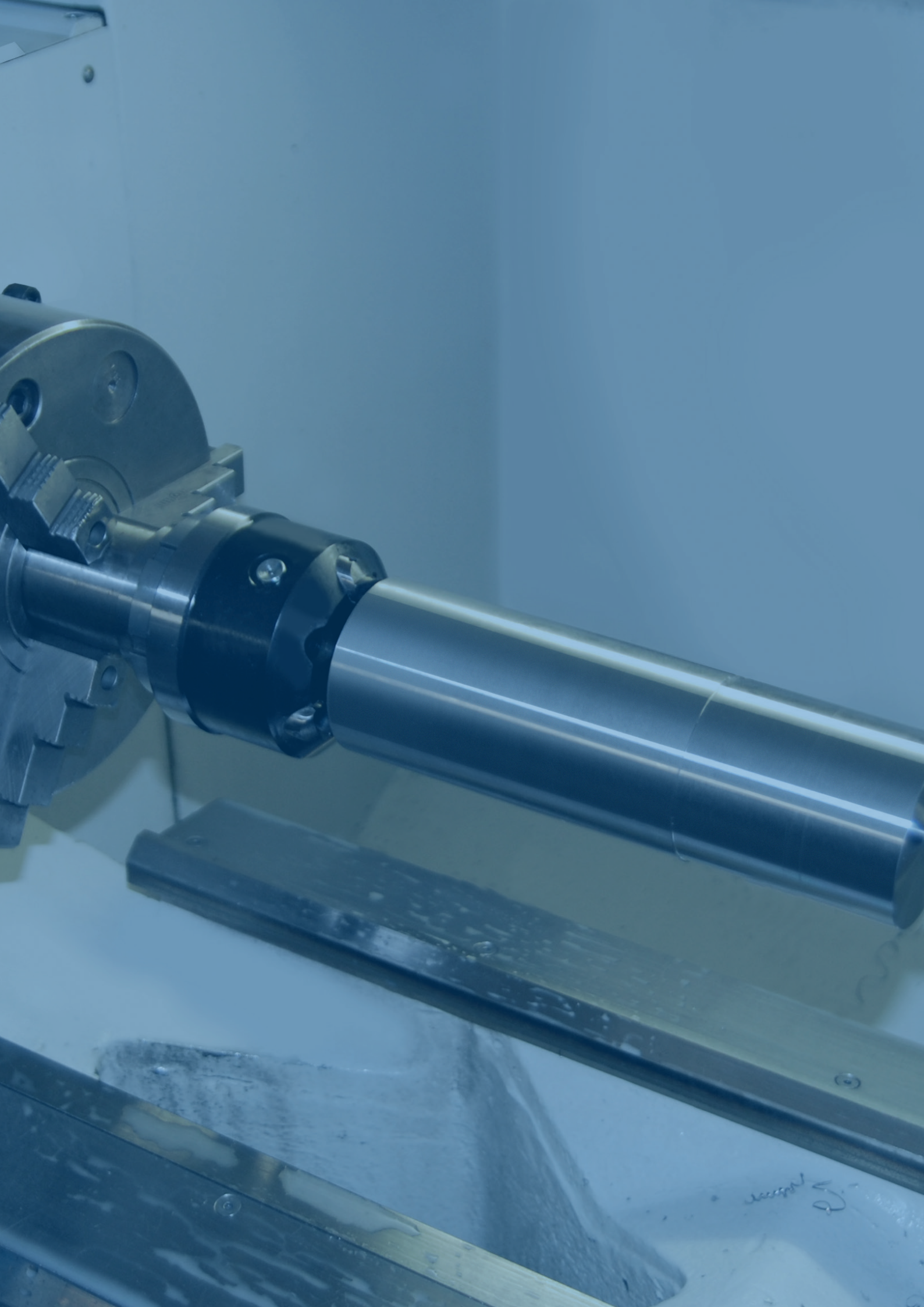

# LIVE CENTRES FACE DRIVERS

EDITION 8.2

**RÖHM**  
driven by technology



# Table of contents

## LIVE CENTRES | FACE DRIVERS



### Live centres

HM Pro - Carbide insert	2008
HMG Pro - Carbide insert with draw-off nut	2009
H Pro - Standard design and HP Pro - Precision design	2010
HG Pro - Standard design with draw-off nut	2011
HZA Pro - Cylindrical shank	2012
HVL Pro - Extended centre point	
HVLP Pro - Extended centre point Precision design	2013
HVLG Pro - Extended centre point with draw-off nut	2014
HVLN Pro - Extended centre point, profiled	2015
HVL Heavy - Extended centre point	2016
HVLG Heavy - Extended centre point with draw-off nut	2017
HVL Speed - Extended centre point with carbide insert	2018
H Slim - Standard design	2019
HVL Slim - Extended centre point	2020
HVLN Slim - Extended centre point, profiled	2021
H Control - Standard design	2022
HVL Control - Extended centre point	2023
A Flex - Interchangeable inserts	2024

### Revolving centering taper

MZK	2029
-----	------

### Solid centres

FZS	2033
-----	------

### Constant face drivers

CoAE	2038
CoK-AE - Power-operated	2050

Special solutions	2054
-------------------	------

# Operation guide

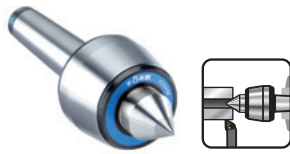

PRO	HM Pro Carbide insert						HMG Pro Carbide insert and draw-off nut					
Size MT	2	3	3	4	5	6	2	3	3	4	5	6
Workpiece weight max. (kg)	120	240	360	500	1000	1800	120	240	360	500	1000	1800
Concentricity deviation max. (mm)	0,005						0,01					
Speed max min <sup>-1</sup>	7000	6300	5000	3800	3000	2600	7000	6300	5000	3800	3000	2600
Page	2008						2009					



PRO	H Pro Standard design HP Pro Precision design									HG Pro Standard design with draw-off nut					
Size MT	1	2	3	3	4	5	6	6	Metr.80	2	3	3	4	5	6
Workpiece weight max. (kg)	100	200	400	500	800	2000	3500	5000	7500	200	400	500	800	2000	3500
Concentricity deviation max. (mm)	H Pro & HG Pro									0,005					
	HP Pro									0,003					
Speed max min <sup>-1</sup>	7000	7000	6300	5000	3800	3000	2600	1500	1500	7000	6300	5000	3800	3000	2600
Page	2010									2011					



PRO	HZA Pro Cylindrical shank			HVLN Pro Extended centre point, profiled			
Size ZA / MT	ZA 20	ZA 25	ZA 32	2	3	4	5
Workpiece weight max. (kg)	130	200	400	100	150	180	280
Concentricity deviation max. (mm)	0,005			0,005			
Speed max min <sup>-1</sup>	7000	5000	3800	7000	5000	3800	3000
Page	2012			2015			



PRO & ORANGE LINE	HVL Pro Extended centre point HVLN Pro Extended centre point Precision design						HVLG Pro Extended centre point with draw-off nut		
Size MT	1	2	3	4	5	6	3	4	5
Workpiece weight max. (kg)	80	140	400	500	1200	2500	400	500	1200
Concentricity deviation max. (mm)	HVL Pro & HVLN Pro						0,01		
	HVLG Pro						0,005		
Concentricity deviation max. (mm)	0,003						0,005		
Speed max min <sup>-1</sup>	7000	7000	5000	3800	3000	2600	5000	3800	3000
Page	2013						2014		

# Operation guide



HEAVY SPEED	HVL Heavy Extended centre point			HVLG Heavy Extended centre point with draw-off nut			HVL Speed Extended centre point, with carbide insert			
Size MT	4	5	6	4	5	6	2	3	4	5
Workpiece weight max. (kg)	1000	2000	3000	1000	2000	3000	100	100	250	250
Concentricity deviation max. (mm)	0,005			0,005			0,01			
Speed max min <sup>-1</sup>	7000	6000	4800	7000	6000	4800	12000	12000	9000	9000
Page	2016			2017			2018			



SLIM	H Slim Standard design					HVL Slim Extended centre point					HVLN Slim Extended centre point, profiled			
Size MT	2	3	4	5	6	2	3	4	5	6	2	3	4	5
Workpiece weight max. (kg)	200	400	800	1600	3500	170	340	700	1400	3000	50	100	150	180
Concentricity deviation max. (mm)	0,005		0,01	0,02	0,008		0,01	0,02	0,008		0,01			
Speed max min <sup>-1</sup>	7000	7000	6300	4300	3000	7000	7000	6300	4300	3000	7000	7000	6300	4300
Page	2019					2020					2021			

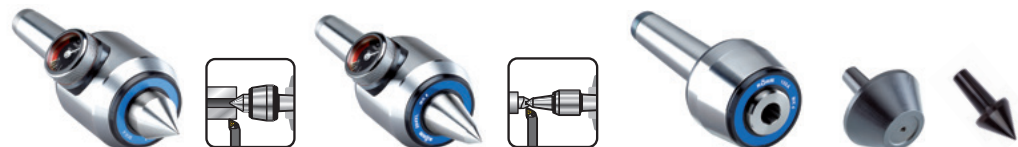

CONTROL FLEX	H Control Standard design				HVL Control Extended centre point				A Flex Interchangeable inserts					
Size MT	3	4	5	6	3	4	5	6	2	3	3	4	5	6
Workpiece weight max. (kg)	400	800	1600	3200	260	550	1100	2500	40	130	150	250	650	900
Concentricity deviation max. (mm)	0,01		0,015	0,01		0,015	0,01		0,015	0,01				0,015
Speed max min <sup>-1</sup>	4000	3500	2500	1800	4000	3500	2500	1800	7000	6300	5000	3800	3000	2600
Page	2022				2023				2024					

# Operation guide



MZK	Revolving centering tapers Pointed				
Size MT	2	3	4	5	6
Workpiece weight max. (kg)	200	400	800	1600	2500
Concentricity deviation max. (mm)	0,01		0,008		
Speed max min <sup>-1</sup>	6000	6000	4000	4000	2500
Page	2029				



MZK	Revolving centering tapers Cone truncated, 60 °						
Size MT	2	2	3	3	4	4	5
Workpiece weight max. (kg)	200	300	400	600	400	800	800
Concentricity deviation max. (mm)	0,008						
Speed max min <sup>-1</sup>	6000	5000	5000	4000	5000	4000	4000
Page	2029						



MZK	Revolving centering tapers Cone truncated, 75 °												
Size MT	2	3	3	4	4	4	5	5	5	6	6	6	
Workpiece weight max. (kg)	300	400	600	400	800	1200	800	1600	2000	1600	2000	4000	
Concentricity deviation max. (mm)	0,008			0,01			0,008			0,01			0,015
Speed max min <sup>-1</sup>	5000	5000	4000	5000	4000	2800	4000	2800	2200	2800	2200	1200	
Page	2029												



MZK	Revolving centering tapers Interchangeable inserts			Revolving centering tapers Interchangeable inserts and draw-off nut			Fixed shafts Interchangeable inserts		
Size MT	4	5	6	4	5	6	4	5	6
Workpiece weight max. (kg)	800	1600	3000	1000	2000	3500	2000	4800	12000
Concentricity deviation max. (mm)	0,005			0,005			0,003		
Speed max min <sup>-1</sup>	3800	3000	2600	7000	6000	4800	-	-	-
Page	2030			2030			2030		

# Operation guide



FZS	Solid centres Full carbide tip				Solid centres Full point, carbide insert and regrinding line			
Size MT	2	3	4	5	2	3	4	5
Concentricity deviation max. (mm)	0,005				0,005			
Page	2033				2033			



FZS	Solid centres Full point							
Size MT	0	1	2	3	4	5	6	
Concentricity deviation max. (mm)	0,005							
Page	2033							



FZS	Solid centres Full point, draw-off nut and SW				Solid centres Full point, draw-off nut, SW and extended point			
Size MT	3	4	5	6	3	4	5	6
Concentricity deviation max. (mm)	0,005				0,005			
Page	2034				2034			



FZS	Solid centres Half point with carbide insert				Solid centres Half point			
Size MT	2	3	4	5	2	3	4	5
Concentricity deviation max. (mm)	0,005				0,005			
Page	2034				2034			

Solid centres in high precision design on request.

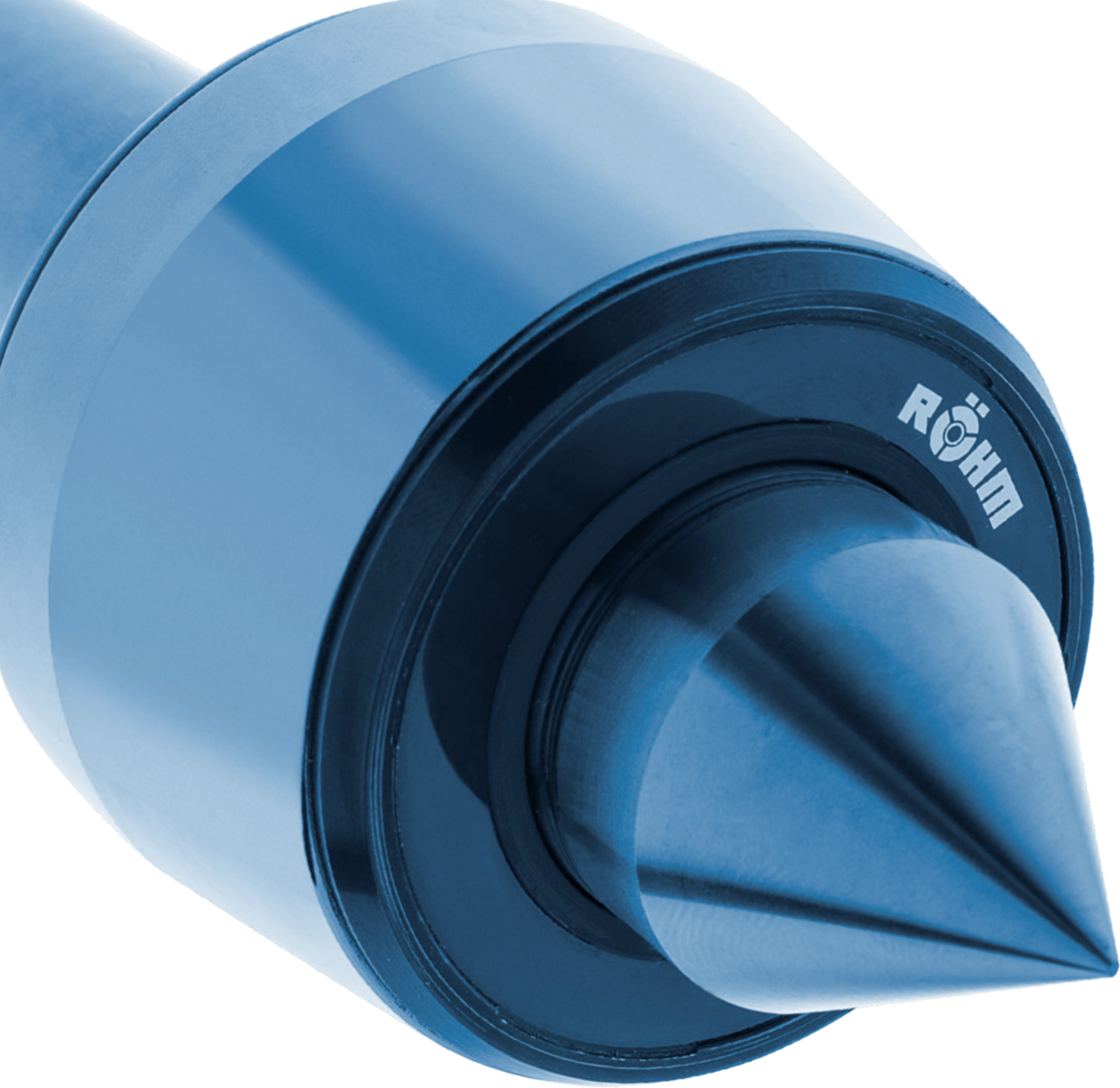

THE RIGHT LIVE CENTRE FOR EVERY APPLICATION

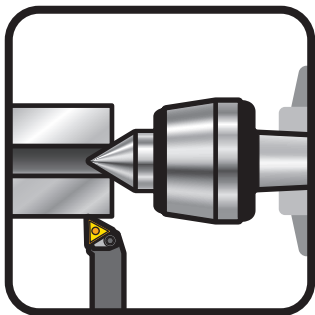

For small and large centres

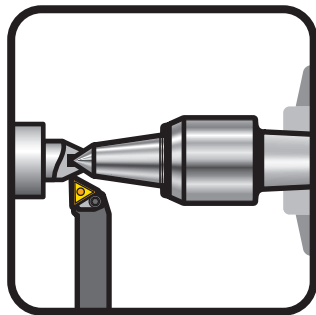

For cramped work area

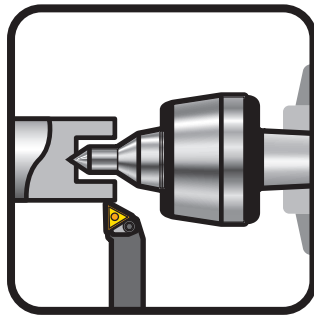

For lower-lying centres

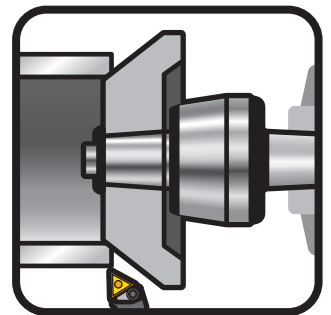

For large boreholes



# LIVE CENTRES

The requirement for high cutting capacities and high working precision demands an additional support by a revolving live centre for many workpieces due to their shape and length. Thanks to their precision bearings, RÖHM live centres offer optimal force absorption and a maximum concentricity deviation of up to 0.003 mm. The centre points are maintenance-free thanks to the lifetime lubrication.

## ADVANTAGES AT A GLANCE

- ⊕ Maximum concentricity and optimal force absorption thanks to proven precision bearings
- ⊕ Special lubrication for long service life and little required maintenance
- ⊕ Minimum interference contour thanks to slender housing shape

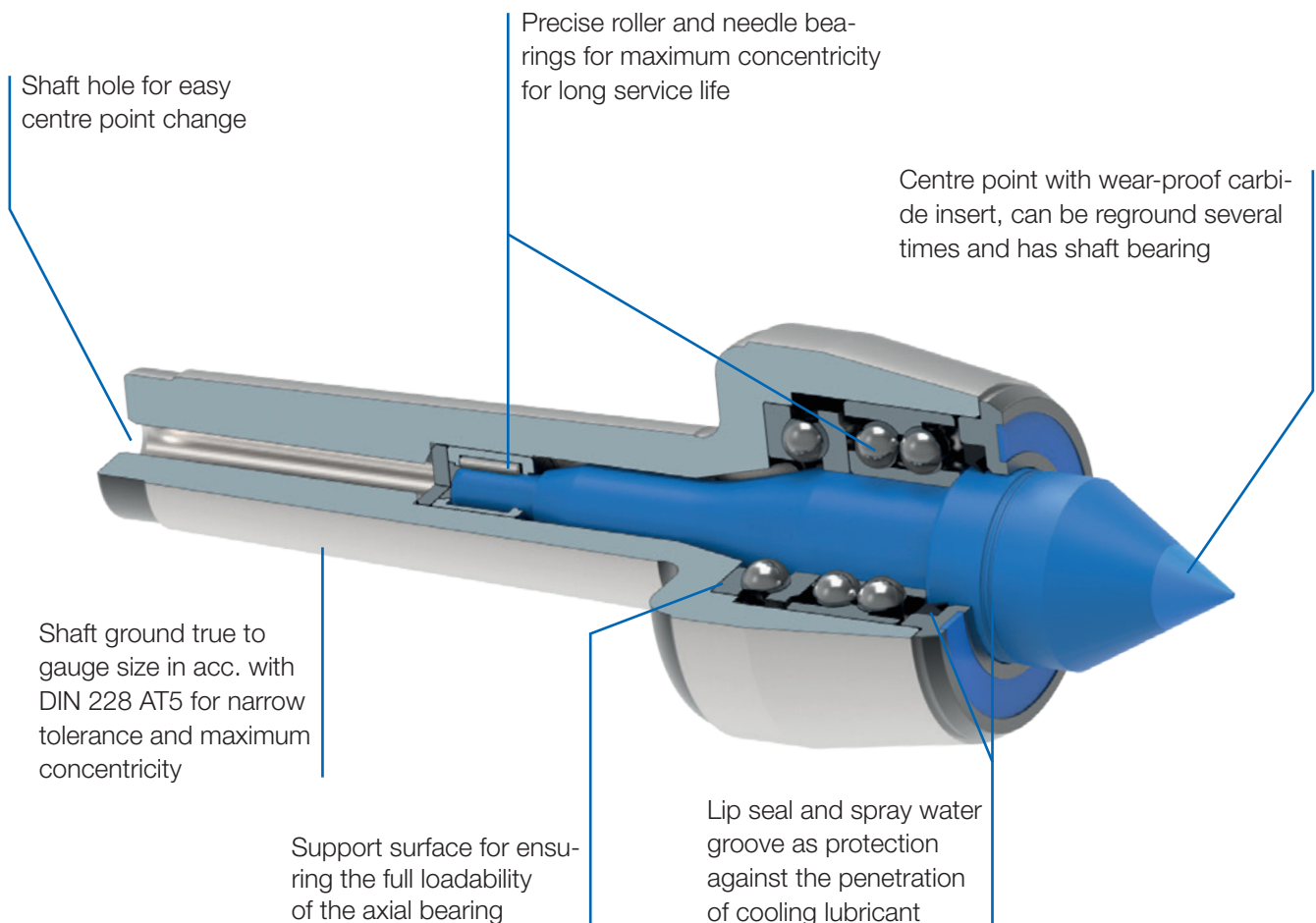

# HM Pro - Carbide insert

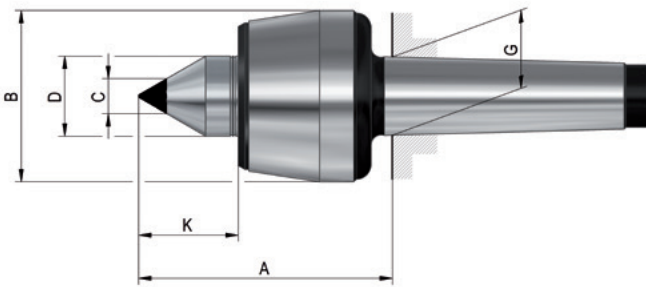
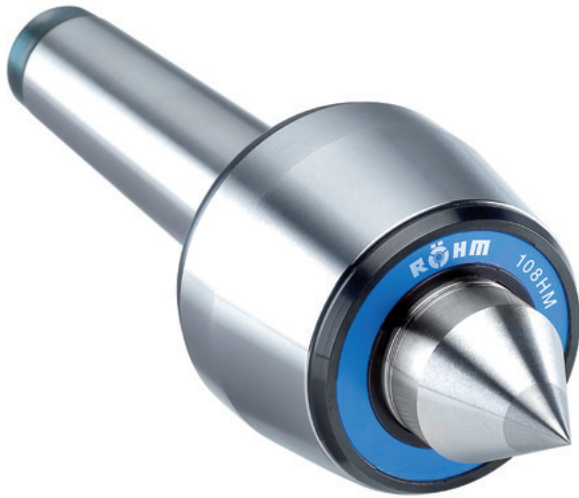

## APPLICATION

For counter-clamping workpieces on turning and grinding machines.

## TYPE

Centre point with wear-proof carbide insert.

## CUSTOMER BENEFITS

- ③ Maximum service life and wear resistance thanks to carbide insert
- ③ High concentricity and stability thanks to 3-fold bearing
- ③ Maximum concentricity deviation of 0.005 mm for maximum precision

## TECHNICAL FEATURES

- Body hardened and ground
- Tip angle 60°

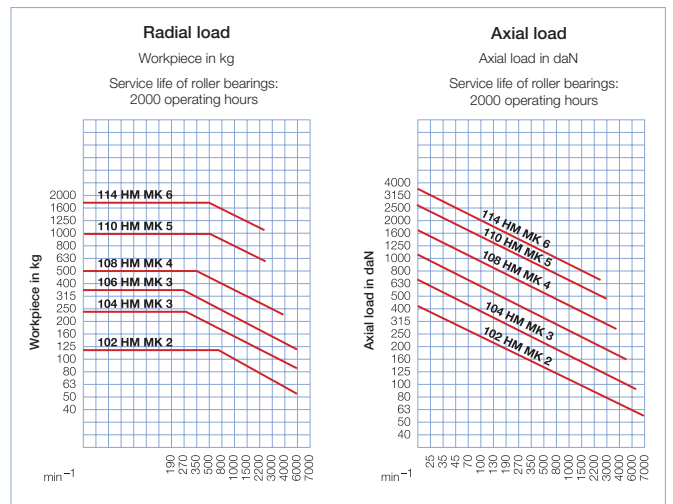
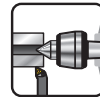

A06

### HM Pro - Carbide insert, body hardened and ground - tip angle 60°

Item no.	032140	090089	237413	093306	221016	221017
Mount MT	2	3	3	4	5	6
Size	102	104	106	108	110	114
A mm	65	70,5	79,5	102,5	129	152
B mm	43	48,5	58,5	68,5	88,5	102,5
C mm	11	11	14	14	18	18
D mm	20	22	25	32	40	50
G mm	17,78	23,825	23,825	31,267	44,399	63,348
K mm	24	27	30,5	40	49,5	57
Weight approx. g	600	900	1300	2300	4700	10000
Workpiece weight max. kg	120	240	360	500	1000	1800
Concentricity deviation max. mm	0,005	0,005	0,005	0,005	0,005	0,01
Speed max. min <sup>-1</sup>	7000	6300	5000	3800	3000	2600
Spare live centres	1241742	1241743	1241744	1241745	1241746	1241747

# HMG Pro - Carbide insert with draw-off nut



## APPLICATION

For counter-clamping workpieces on turning and grinding machines.

## TYPE

Centre point with wear-proof carbide insert.  
With draw-off nut.

## CUSTOMER BENEFITS

- ⊕ Maximum service life and wear resistance thanks to carbide insert
- ⊕ High concentricity and stability thanks to 3-fold bearing
- ⊕ Maximum concentricity deviation of 0.005 mm for maximum precision

## TECHNICAL FEATURES

- Body hardened and ground
- Tip angle 60°

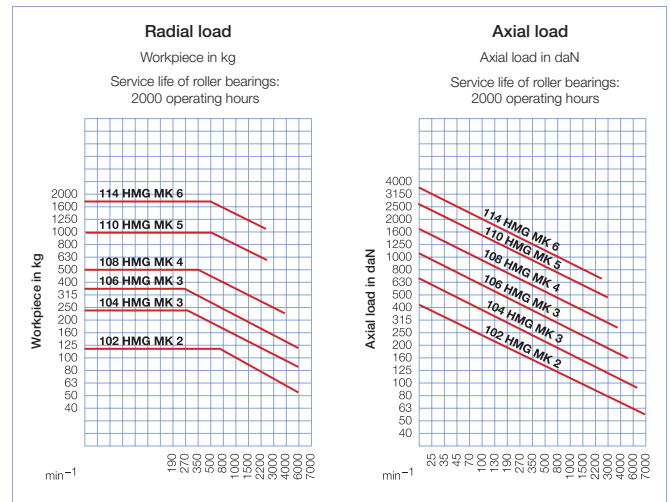
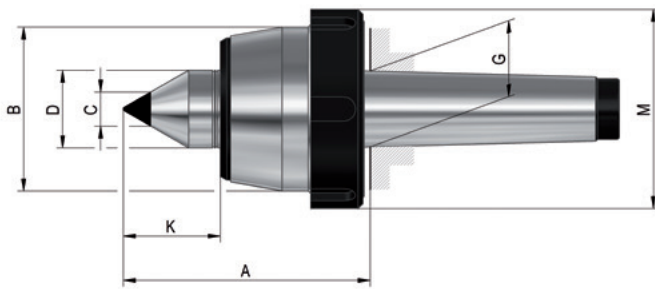

A06

**HMG Pro - Carbide insert with draw-off nut, body hardened and ground - tip angle 60°**

Item no.	221021	221022	221023	221024	221025	221026
Mount MT	2	3	3	4	5	6
Size	102	104	106	108	110	114
A mm	65	70,5	79,5	102,5	129	152
B mm	45	50	60	70	90	105
C mm	11	11	14	14	18	18
D mm	20	22	25	32	40	50
G mm	17,78	23,825	23,825	31,265	44,399	63,348
K mm	24	27	30,5	40	49,5	57
M mm	56	62	74	82	105	120
Weight approx. g	600	1000	1400	2400	5200	10500
Workpiece weight max. kg	120	240	360	500	1000	1800
Concentricity deviation max. mm	0,005	0,005	0,005	0,005	0,005	0,01
Speed max. min <sup>-1</sup>	7000	6300	5000	3800	3000	2600
Spare live centres	1241742	1241743	1241744	1241745	1241746	1241747

# H Pro - Standard design

## HP Pro - Precision design

Live centres



### APPLICATION

For counter-clamping workpieces on turning and grinding machines.

### TYPE

All-round live centre in classical design for nearly any standard clamping situation.

### CUSTOMER BENEFITS

- ⊕ Proven 3-fold bearing for high axial and radial load
- ⊕ Lifetime lubrication for minimum required maintenance
- ⊕ Maximum concentricity deviation of 0.005 mm (for H Pro) and 0,003 mm (for HP Pro) for maximum precision

### TECHNICAL FEATURES

- Body hardened and ground (MT 1 - Metr. 80)
- Tip angle 60°

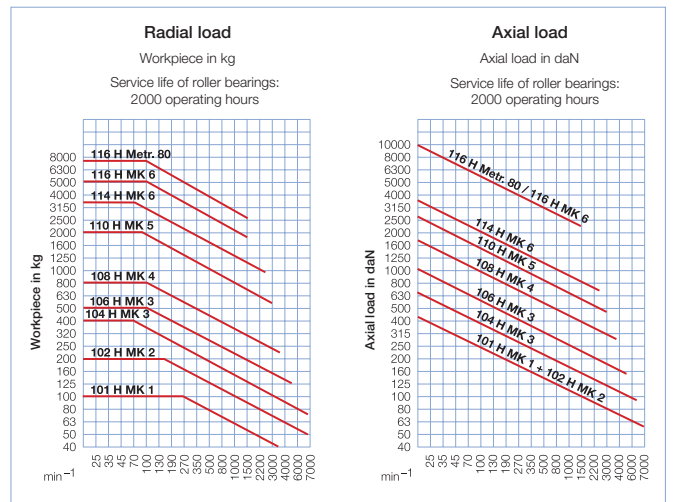
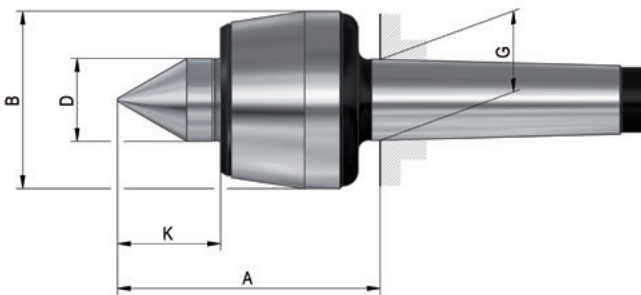
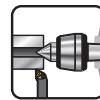

A06

### H Pro - Standard design and HP Pro - Precision design, body hardened and ground - tip angle 60°

Item no. H Pro HP Pro	043400 -	043115 082392	042315 -	042776 318227	042175 082394	042843 082395	043532 1263871	093439 -	093440 -
Mount MT	1	2	3	3	4	5	6	6	Metr. 80
Size	101	102	104	106	108	110	114	116	116
A mm	60,5	65	70,5	79,5	102,5	129	152	196	196
B mm	34,5	43	48,5	58,5	68,5	88,5	102,5	138,5	138,5
D mm	15	20	22	25	32	40	50	60	60
G mm	12,065	17,78	23,825	23,825	31,267	44,399	63,348	63,348	80
K mm	17	24	27	30,5	40	49,5	57	66	66
Weight approx. g	400	500	800	1300	2300	4700	10200	17800	23000
Workpiece weight max. kg	100	200	400	500	800	2000	3500	5000	7500
Concentricity deviation max. mm	H Pro 0,005 HP Pro -	0,005 0,003	0,005 -	0,005 0,003	0,005 0,003	0,005 0,003	0,008 0,003	0,01 -	0,015 -
Speed max. min <sup>-1</sup>	7000	7000	6300	5000	3800	3000	2600	1500	1500
Spare live centres	1241726	1241725	1241724	1241723	1241722	1241721	1241728	1241729	1241730

<sup>1)</sup> Body only ground not hardened

# HG Pro - Standard design with draw-off nut



## APPLICATION

For counter-clamping workpieces on turning and grinding machines.

## TYPE

All-round live centre in classical design for nearly any standard clamping situation. With draw-off nut.

## CUSTOMER BENEFITS

- ⊕ Proven 3-fold bearing for high axial and radial load
- ⊕ Lifetime lubrication for minimum required maintenance
- ⊕ Maximum concentricity deviation of 0.005 mm for maximum precision

## TECHNICAL FEATURES

- Body hardened and ground (MT 2 - 6)
- Tip angle 60°

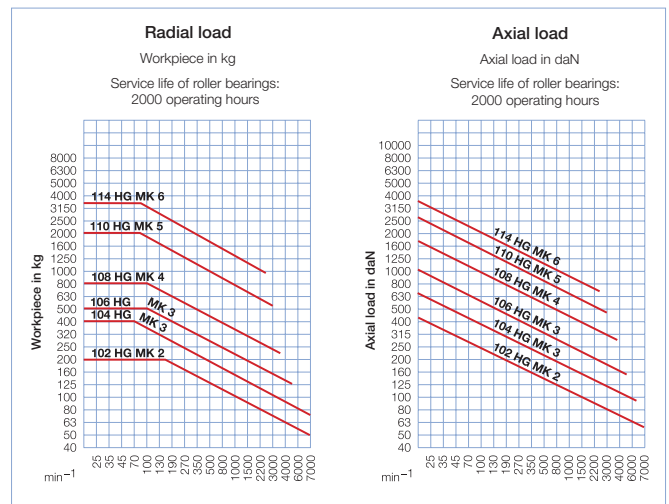
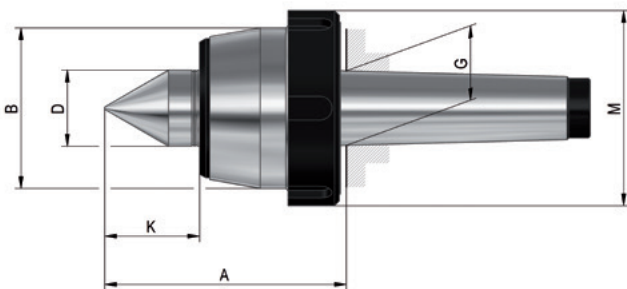

A06

### HG Pro - Standard design with draw-off nut, body hardened and ground - tip angle 60°

Item no.	221018	221019	205036	207148	074390	221020
Mount MT	2	3	3	4	5	6
Size	102	104	106	108	110	114
A mm	65	70,5	79,5	102,5	129	152
B mm	45	50	60	70	90	105
D mm	20	22	25	32	40	50
G mm	17,78	23,825	23,825	31,267	44,399	63,348
K mm	24	27	30,5	40	49,5	57
M mm	56	62	74	82	105	120
Weight approx. g	600	1000	1400	2400	5200	10500
Workpiece weight max. kg	200	400	500	800	2000	3500
Concentricity deviation max. mm	0,005	0,005	0,005	0,005	0,005	0,008
Speed max. min <sup>-1</sup>	7000	6300	5000	3800	3000	2600
Spare live centres	1241725	1241724	1241723	1241722	1241721	1241728

Version with extended centre point on request

# HZA Pro - Cylindrical shank



## APPLICATION

For counter-clamping of workpieces on turning and grinding machines using lathe chucks, collet chucks and tool take-ups.  
Take-up for tool magazine / turret.

## TYPE

All-round live centre with cylinder shaft.

## CUSTOMER BENEFITS

- ⊕ Proven 3-fold bearing for high axial and radial load
- ⊕ Lifetime lubrication for minimum required maintenance
- ⊕ Maximum concentricity deviation of 0.005 mm for maximum precision

## TECHNICAL FEATURES

- Body hardened and ground
- Tip angle 60°

### Note:

Live centres with cylindrical shank and with clamping surface on request

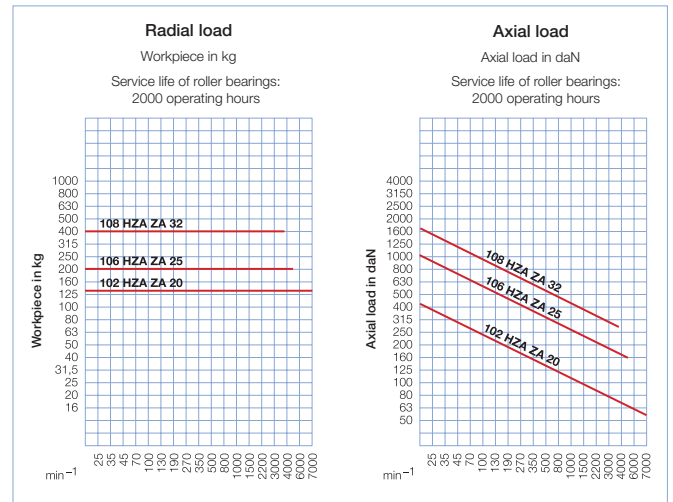
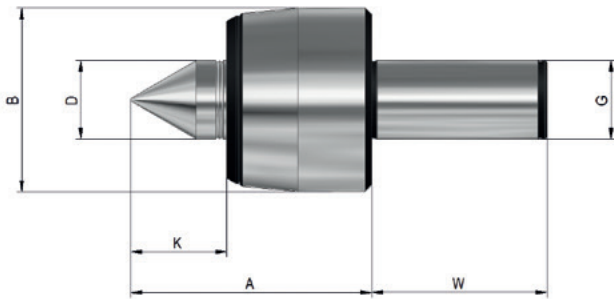
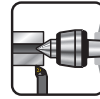

A06  
HZA Pro - Cylindrical shank, body hardened and ground - tip angle 60°

Item no.	1316054	1316055	1316056
Mount MT	ZA20	ZA25	ZA32
Size	102	106	108
A mm	58	76,8	93,1
B mm	43	48,5	68,5
D mm	20	25	32
G mm	20 h6	25 h6	32 h6
K mm	24	30,5	40
W mm	50	56	60
Weight approx. g	414	891	1474
Workpiece weight max. kg	130	200	400
Concentricity deviation max. mm	0,005	0,005	0,005
Speed max. min <sup>-1</sup>	7000	5000	3800
Spare live centres	1241725	1241723	1241722

# HVL Pro - Extended centre point HVL Pro - Extended centre point with draw-off nut Precision design



## APPLICATION

For counter-clamping workpieces on turning and grinding machines. Especially suited for cramped work area between centre point and workpiece.

## TYPE

All-round live centre with extended centre point.

## CUSTOMER BENEFITS

- ① Enlarged work area and better workpiece accessibility thanks to extended centre point
- ② High concentricity and stability thanks to 3-fold bearing
- ③ Maximum concentricity deviation of 0.005 mm (for HVL Pro) and 0.003 mm (for HVL Pro) for maximum precision

## TECHNICAL FEATURES

- Body hardened and ground
- Tip angle 60°

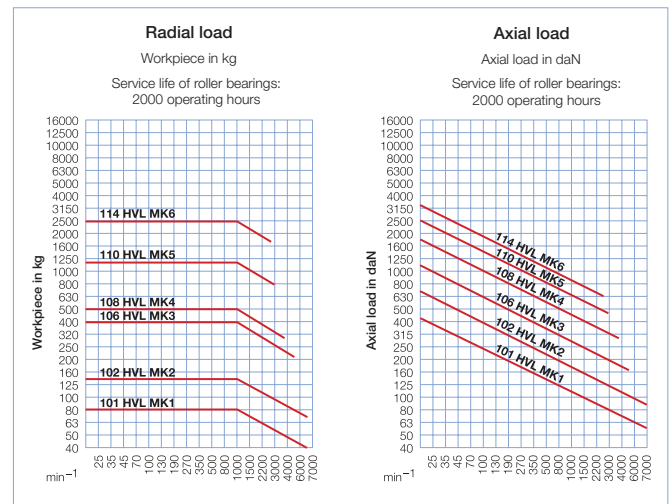
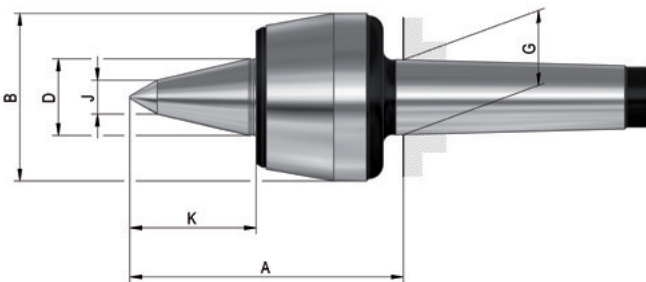
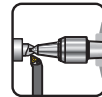

A06

**HVL Pro - Extended centre point and HVL Pro - Extended centre point with draw-off nut Precision design, body hardened and ground - tip angle 60°**

Item no.	HVL Pro	058668	058669	058670	058671	058672	058673
	HVL Pro			1412291	1412292	1412293	1412294
Mount MT		1	2	3	4	5	6
Size		101	102	106	108	110	114
A mm		70,5	75	95,5	114,5	143,5	172,5
B mm		34,5	43	58,5	68,5	88,5	102,5
D mm		15	20	25	32	40	50
G mm		12,065	17,78	23,825	31,267	44,399	63,348
K mm		27	34	47	53	64	78
J mm		9	10	12	14	16	18
Weight approx. g		400	500	1300	2300	4800	10200
Workpiece weight max. kg		80	140	400	500	1200	2500
Concentricity deviation max. mm	HVL Pro	0,01	0,005	0,005	0,005	0,005	0,01
	HVL Pro	-	-	0,003	0,003	0,003	0,003
Speed max. min <sup>-1</sup>		7000	7000	5000	3800	3000	2600
Spare live centres		1241731	1241732	1241733	1241734	1241735	1241736

# HVLG Pro - Extended centre point with draw-off nut

Live centres



## APPLICATION

For counter-clamping workpieces on turning and grinding machines. Especially suited for cramped work area between centre point and workpiece.

## TYPE

All-round live centre with extended centre point.

## CUSTOMER BENEFITS

- ① Enlarged work area and better workpiece accessibility thanks to extended centre point
- ② High concentricity and stability thanks to 3-fold bearing
- ③ Maximum concentricity deviation of 0.005 mm for maximum precision

## TECHNICAL FEATURES

- Body hardened and ground
- Tip angle 60°

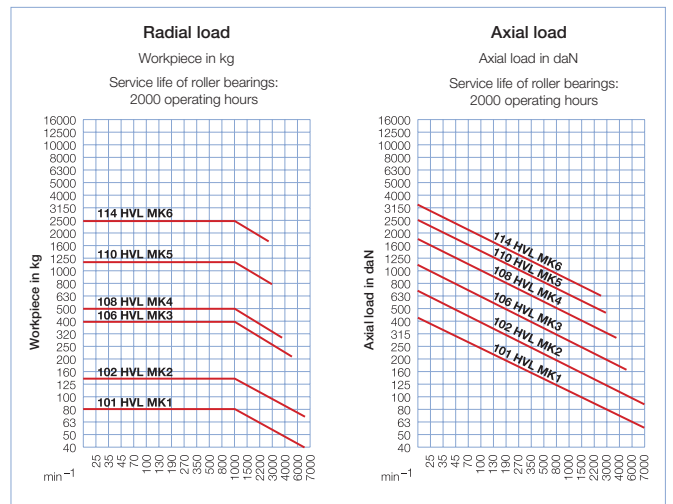
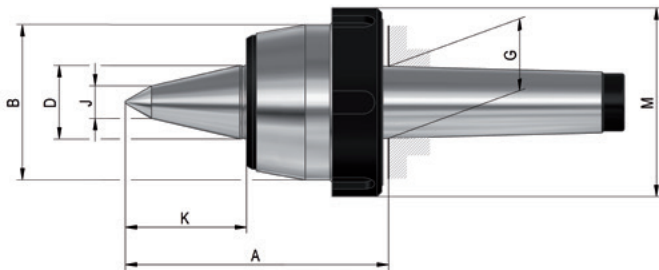
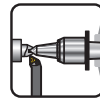

A06

**HVLGP Pro - Extended centre point with draw-off nut, body hardened and ground - tip angle 60°**

Item no.	246746	90208	205098
Mount MT	3	4	5
Size	106	108	110
A mm	95,5	114,5	143,5
B mm	58,5	68,5	88,5
D mm	25	32	40
G mm	23,825	31,267	44,399
K mm	47	53	64
J mm	12	14	16
M mm	74	82	105
Weight approx. g	1300	2300	4800
Workpiece weight max. kg	400	500	1200
Concentricity deviation max. mm	0,005	0,005	0,005
Speed max. min <sup>-1</sup>	5000	3800	3000
Spare live centres	1241733	1241734	1241735



# HVLN Pro - Profiled, extended centre point



## APPLICATION

For counter-clamping workpieces on turning and grinding machines. Especially suited for cramped work area between centre point and workpiece as well as low-lying workpiece centres.

## TYPE

All-round live centre with profiled and extended centre point.

## CUSTOMER BENEFITS

- ⊕ Enlarged work area and better workpiece accessibility thanks to profiled and extended centre point
- ⊕ High concentricity and stability thanks to 3-fold bearing
- ⊕ Maximum concentricity deviation of 0.005 mm for maximum precision

## TECHNICAL FEATURES

- Body hardened and ground
- Tip angle 60°

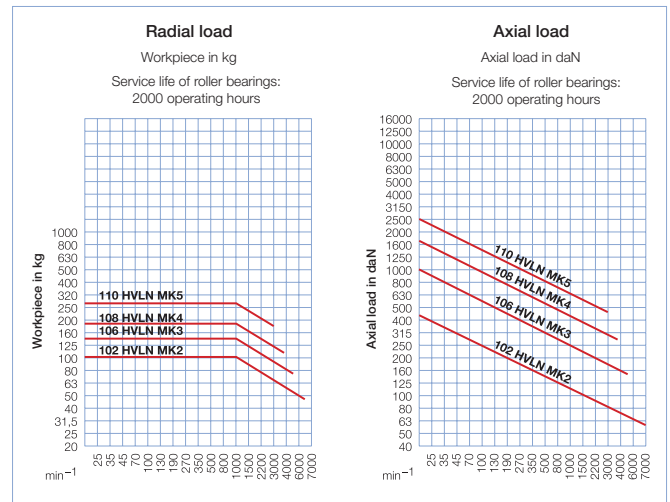
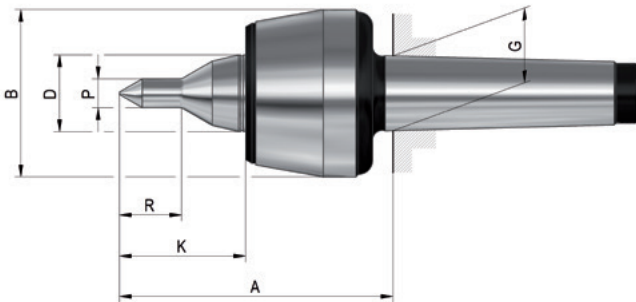
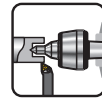

A06

### HVLN Pro - Profiled, extended centre point, body hardened and ground - tip angle 60°

Item no.	1241689	1241691	1241693	1241694
Mount MT	2	3	4	5
Size	102	106	108	110
A mm	75	95,5	114,5	143,5
B mm	43	58,5	68,5	88,5
D mm	20	25	32	40
G mm	17,78	23,825	31,267	44,399
K mm	34	47	53	64
P mm	8	10	12	14
R mm	16	20	26	30
Workpiece weight max. kg	100	150	180	280
Concentricity deviation max. mm	0,005	0,005	0,005	0,005
Speed max. min <sup>-1</sup>	7000	5000	3800	3000
Weight approx. g	320	460	1000	2600
Spare live centres	1243677	1243678	1243679	1243680

Version with draw-off nut on request

# HVL Heavy - Extended centre point



## APPLICATION

For counter-clamping especially heavy workpieces on turning and grinding machines.  
Especially suitable for use on NC-machines.

## TYPE

Universal version with extended centre point for heavy workpieces.

## CUSTOMER BENEFITS

- ① Robust 4-fold precision bearing for high speeds as well as high axial and radial loads
- ② Reliable and safe clamping of heavy workpieces
- ③ Maximum concentricity deviation of 0.005 mm for maximum precision

## TECHNICAL FEATURES

- Body hardened and ground
- Tip angle 60°

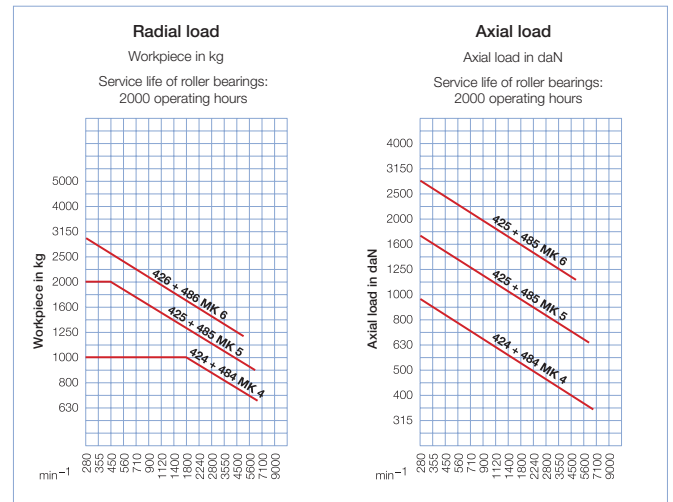
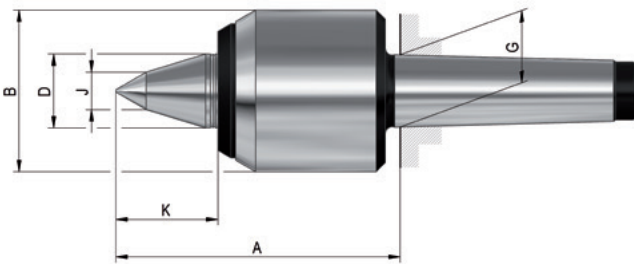
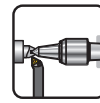

A06

**HVL Heavy - Extended centre point, especially for high load at high speeds, body hardened and ground - tip angle 60°**

Item no.	303598	303599	301696
Mount MT	4	5	6
Size	424	425	426
A mm	122	150	180
B mm	70	95	120
D mm	32	42	58
G mm	31,267	44,399	63,348
J mm	16	20	26
K mm	44,5	59,5	76
Weight approx. g	2600	5500	11500
Workpiece weight max. kg	1000	2000	3000
Concentricity deviation max. mm	0,005	0,005	0,005
Speed max. min <sup>-1</sup>	7000	6000	4800
Spare live centres	1241762	1241763	1241764

# HVLG Heavy - Extended centre point with draw-off nut



## APPLICATION

For counter-clamping especially heavy workpieces on turning and grinding machines. Especially suitable for use on NC-machines.

## TYPE

Universal version with extended centre point for heavy workpieces. With draw-off nut.

## CUSTOMER BENEFITS

- ⊕ Robust 4-fold precision bearing for high speeds as well as high axial and radial loads
- ⊕ Reliable and safe clamping of heavy workpieces
- ⊕ Maximum concentricity deviation of 0.005 mm for maximum precision

## TECHNICAL FEATURES

- Body hardened and ground
- Tip angle 60°

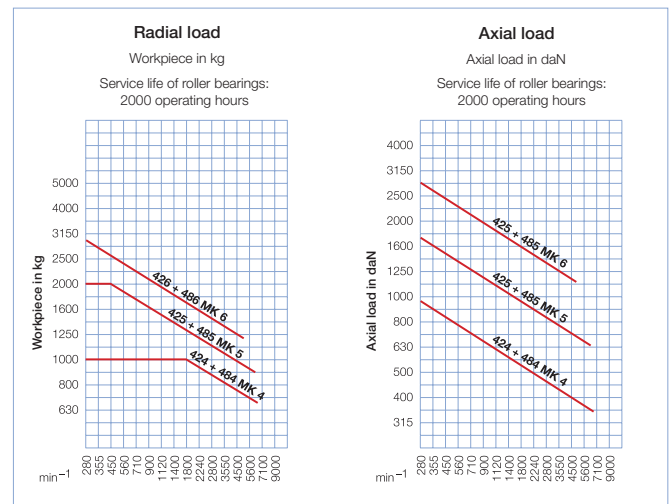
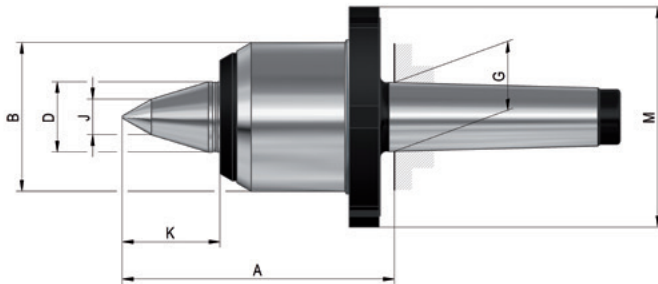
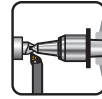

A06  
HVLG Heavy - Extended centre point with draw-off nut, especially for high load at high speeds, body hardened and ground - tip angle 60°

Item no.	304521	304522	304523
Mount MT	4	5	6
Size	484	485	486
A mm	122	150	180
B mm	70	95	120
D mm	32	42	58
G mm	31,267	44,399	63,348
J mm	16	20	26
K mm	44,5	59,5	76
M mm	100	125	155
Weight approx. g	2800	5400	12300
Workpiece weight max. kg	1000	2000	3000
Concentricity deviation max. mm	0,005	0,005	0,005
Speed max. min <sup>-1</sup>	7000	6000	4800
Spare live centres	1241762	1241763	1241764

# HVL Speed - Extended centre point



## APPLICATION

For counter-clamping workpieces on turning and grinding machines. Especially suitable for complex machining at high speeds.

## TYPE

Special design for very high speeds with extended centre point and wear-resistant carbide insert.

## CUSTOMER BENEFITS

- ⊕ Maximum rigidity for high speeds up to 12000 rpm thanks to compact design
- ⊕ Enlarged work area and better workpiece accessibility thanks to extended centre point
- ⊕ Maximum concentricity deviation of 0.01 mm for maximum precision

## TECHNICAL FEATURES

- Body hardened and ground
- Tip angle 60°

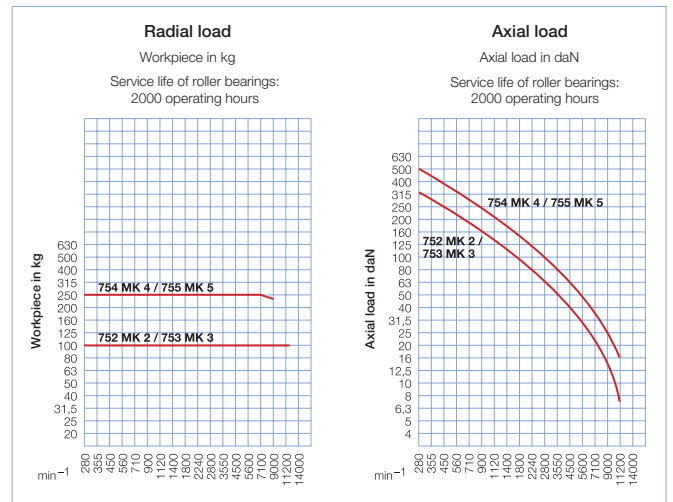
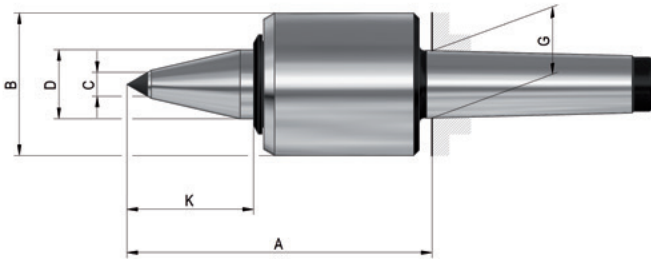
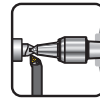

A06

**HVL - Extended centre point, with carbide insert, for high speed, body hardened and ground - tip angle 60°**

Item no.	772389	772390	772391	772392
Mount MT	2	3	4	5
Size	752	753	754	755
A mm	99	99	141	141
B mm	45	45	66	66
C mm	7	7	11	11
D mm	20	20	32	32
G mm	17,78	23,825	31,267	44,399
K mm	40	40	63	63
Weight approx. g	1200	1600	2600	5000
Workpiece weight max. kg	100	100	250	250
Concentricity deviation max. mm	0,01	0,01	0,01	0,01
Speed max. min <sup>-1</sup>	12000	12000	9000	9000
Spare live centres	790267	790267	790291	790291

# H Slim - Standard design

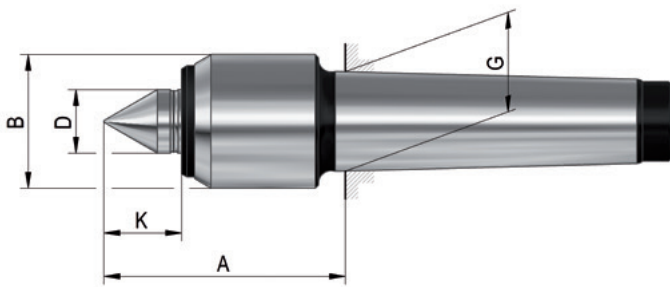

## APPLICATION

For counter-clamping workpieces on turning and grinding machines. Especially suited for cramped work area between centre point and workpiece.

## TYPE

Compact design with minimum casing diameter.

## CUSTOMER BENEFITS

- ⊕ Enlarged work area and better workpiece accessibility thanks to narrow casing diameter
- ⊕ Maximum rigidity at high speeds thanks to compact design
- ⊕ Maximum concentricity deviation of 0.005 mm for maximum precision

## TECHNICAL FEATURES

- Body hardened and ground
- Tip angle 60°

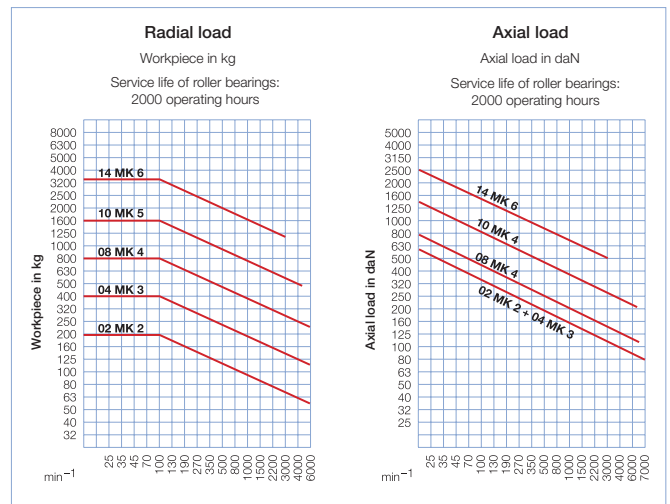
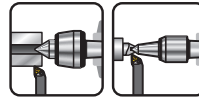

A06

**H Slim - Standard design, with small casing diameter, body hardened and ground - tip angle 60°**

Item no.	005336	005429	005469	005490	005547
Mount MT	2	3	4	5	6
Size	02	04	08	10	14
A mm	62	62	75,5	106	143
B mm	32	34	42	58	80
D mm	15	15	20	30	42
G mm	17,78	23,825	31,267	44,399	63,348
K mm	19,5	19,5	24,5	37	49,5
Weight approx. g	300	400	1000	2600	7100
Workpiece weight max. kg	200	400	800	1600	3500
Concentricity deviation max. mm	0,005	0,005	0,005	0,01	0,02
Speed max. min <sup>-1</sup>	7000	7000	6300	4300	3000

# HVL Slim - Extended centre point



## APPLICATION

For counter-clamping workpieces on turning and grinding machines. Especially suited for cramped work area between centre point and workpiece as well as low-lying workpiece centres.

## TYPE

Compact design with minimum casing diameter. With extended centre point.

## CUSTOMER BENEFITS

- ③ Enlarged work area and better workpiece accessibility thanks to narrow casing diameter and extended centre point
- ③ Maximum rigidity at high speeds thanks to compact design
- ③ Maximum concentricity deviation of 0.008 mm for maximum precision

## TECHNICAL FEATURES

- Body hardened and ground
- Tip angle 60°

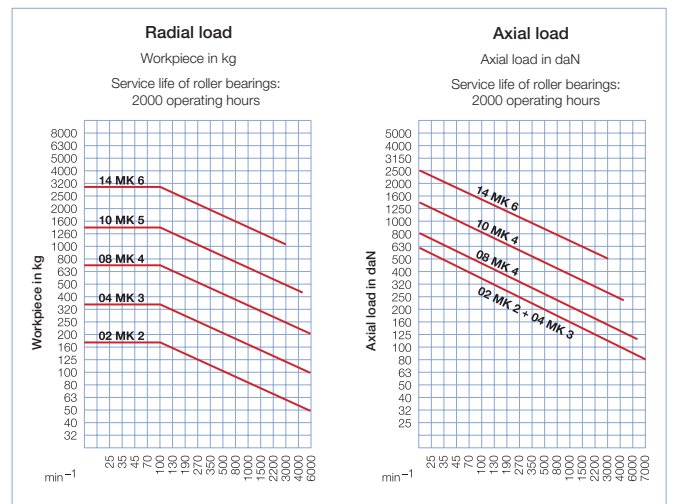
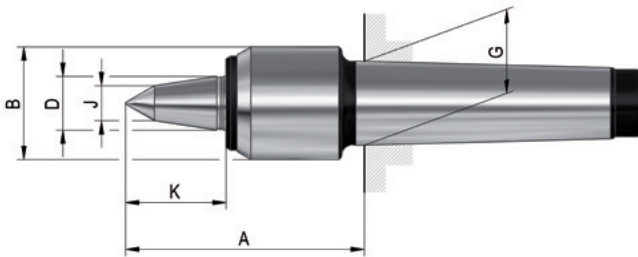
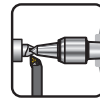

A06

**HVL Slim - Extended centre point, with small casing diameter and extended centre point, body hardened and ground - tip angle 60°**

Item no.	362080	362081	362082	362083	362084
Mount MT	2	3	4	5	6
Size	02	04	08	10	14
A mm	73	74	88,5	119	164
B mm	32	34	42	58	80
D mm	15	15	20	30	42
G mm	17,78	23,825	31,267	44,399	63,348
K mm	29,5	32	37,5	51,5	70,5
J mm	10	11	13	14	18
Weight approx. g	320	460	1000	2600	7100
Workpiece weight max. kg	170	340	700	1400	3000
Concentricity deviation max. mm	0,008	0,008	0,008	0,01	0,02
Speed max. min <sup>-1</sup>	7000	7000	6300	4300	3000

# HVLN Slim - Profiled, extended centre point

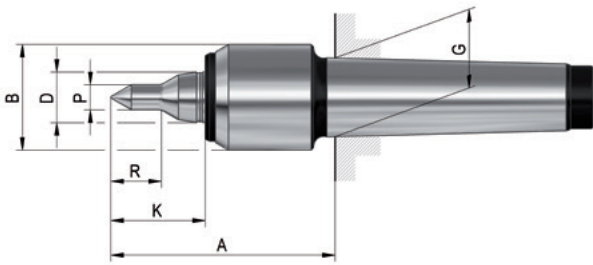

## APPLICATION

For counter-clamping workpieces on turning and grinding machines. Especially suited for cramped work area between centre point and workpiece.

## TYPE

Compact design with minimum casing diameter. With extended and profiled centre point.

## CUSTOMER BENEFITS

- ⊕ Enlarged work area and better workpiece accessibility thanks to narrow casing diameter and extended and profiled centre point
- ⊕ Maximum rigidity at high speeds thanks to compact design
- ⊕ Maximum concentricity deviation of 0.008 mm for maximum precision

## TECHNICAL FEATURES

- Body hardened and ground
- Tip angle 60°

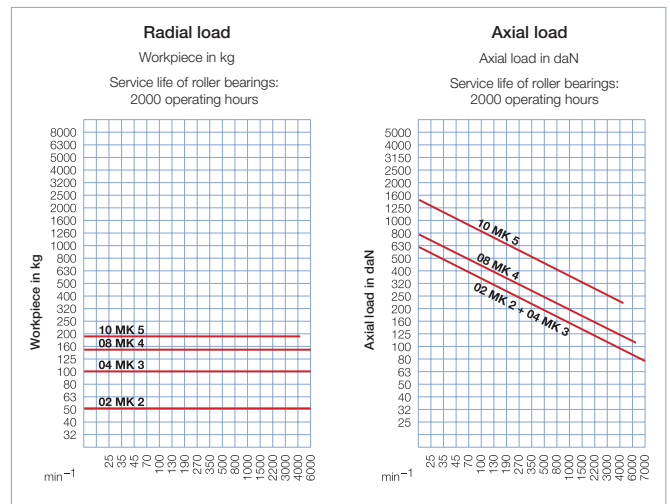
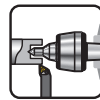

A06

**HVLN Slim - Profiled, extended centre point, with small casing diameter and profiled and extended centre point, body hardened and ground - tip angle 60°**

Item no.	1241695	1243505	1243507	1243509
Mount MT	2	3	4	5
Size	02	04	08	10
A mm	73	74	88,5	119
B mm	32	34	42	58
D mm	15	15	20	30
G mm	17,78	23,825	31,267	44,399
K mm	29,5	32	37,5	51,5
P mm	6	8	10	12
R mm	12	16	20	26
Workpiece weight max. kg	50	100	150	180
Concentricity deviation max. mm	0,008	0,008	0,008	0,01
Speed max. min <sup>-1</sup>	7000	7000	6300	4300
Weight approx. g	320	460	1000	2600

# H Control - Standard design

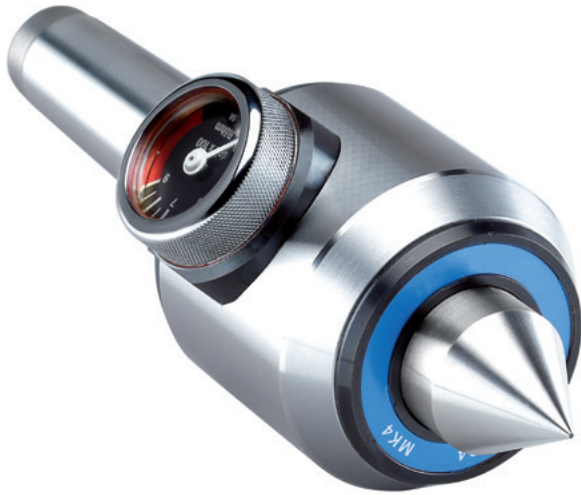

## APPLICATION

For counter-clamping workpieces on turning and grinding machines. Optimally suited as counter-centre for face drivers.

## TYPE

With pressure display and length compensation.

## CUSTOMER BENEFITS

- ⊕ Fast adjustment and check of axial load by means of pressure display
- ⊕ Resilient centre point for safe, deformation-free workpiece clamping
- ⊕ Maximum concentricity deviation of 0.01 mm for maximum precision

## TECHNICAL FEATURES

- Body hardened and ground
- Tip angle 60°

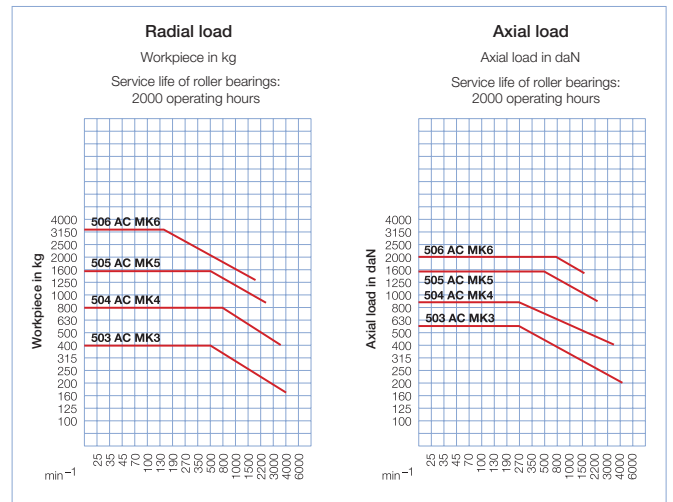
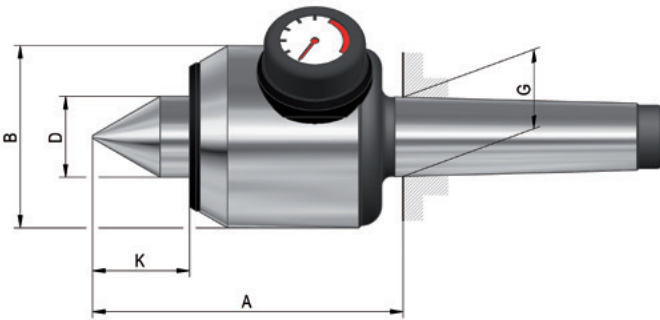
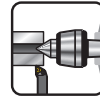

A06  
**H Control - Standard design, with pressure display and length compensation as counter-centre for face drivers, body hardened and ground - tip angle 60°**

Item no.	060798	060874	060906	060915
Mount MT	3	4	5	6
Size	503	504	505	506
A mm	105	123,5	160,5	202
B mm	64	72	95	120
D mm	25	32	40	52
G mm	23,825	31,267	44,399	63,348
K mm	31	38,5	49	59
Weight approx. g	2100	3500	8300	17000
Spring way max. mm <sup>1)</sup>	1,6	2	1,8	2,7
Axial load max. N	5500	9000	15000	20000
Workpiece weight max. kg	400	800	1600	3200
Concentricity deviation max. mm	0,01	0,01	0,01	0,015
Speed max. min <sup>-1</sup>	4000	3500	2500	1800
Spare live centres	009192	009205	009325	009413

<sup>1)</sup> At max. axial load



# HVL Control - Extended centre point



## APPLICATION

For counter-clamping workpieces on turning and grinding machines. Especially suited as counter-centre for face drivers as well as for cramped work area between centre point and workpiece.

## TYPE

With pressure display, length compensation and extended centre point.

## CUSTOMER BENEFITS

- ⊕ Fast adjustment and check of axial load by means of pressure display
- ⊕ Enlarged work area and better workpiece accessibility thanks to extended centre point
- ⊕ Resilient centre point for safe, deformation-free workpiece clamping
- ⊕ Maximum concentricity deviation of 0.01 mm for maximum precision

## TECHNICAL FEATURES

- Body hardened and ground
- Tip angle 60°

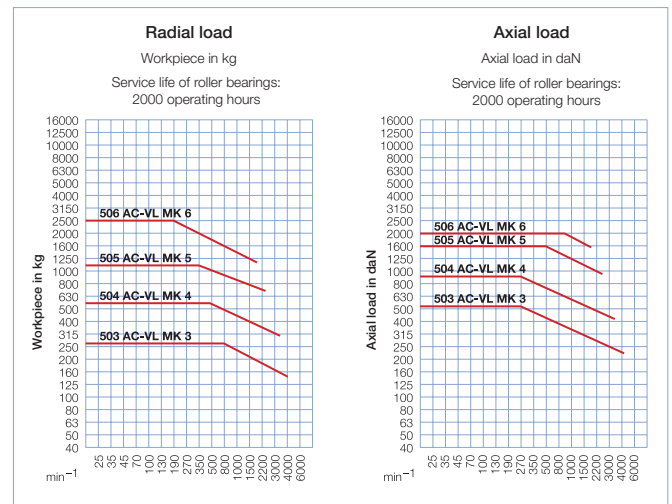
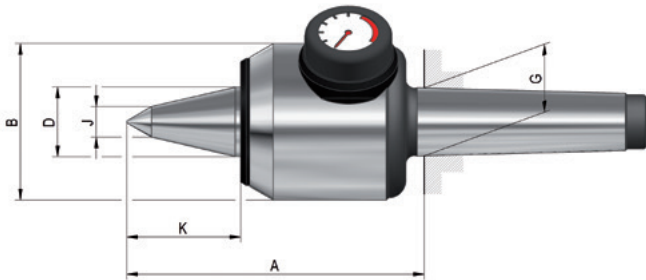
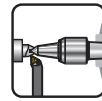

A06  
**HVL Control - Extended centre point, with pressure display, length compensation and extended centre point as counter-centre for face drivers, body hardened and ground - tip angle 60°**

Item no.	079920	079921	079922	079923
Mount MT	3	4	5	6
Size	503	504	505	506
A mm	120	137,5	177,5	223
B mm	64	72	95	120
D mm	25	32	40	52
G mm	23,825	31,267	44,399	63,348
K mm	45,5	52,5	66	80
J mm	11	14	15	24
Weight approx. g	2200	3600	8400	17500
Spring way max. mm <sup>1)</sup>	1,6	2	1,8	2,7
Axial load max. N	5500	9000	15000	20000
Workpiece weight max. kg	260	550	1100	2500
Concentricity deviation max. mm	0,01	0,01	0,01	0,015
Speed max. min <sup>-1</sup>	4000	3500	2500	1800
<b>Spare live centres</b>	<b>079924</b>	<b>079925</b>	<b>079926</b>	<b>079927</b>

<sup>1)</sup> At max. axial load

# A Flex - Interchangeable inserts



## APPLICATION

For counter-clamping workpieces on turning and grinding machines.

## TYPE

With interchangeable inserts made of wear-resistant tool steel for maximum flexibility.

## CUSTOMER BENEFITS

- ② Wide range of applications thanks to interchangeable inserts
- ② Quick change of interchangeable inserts

## TECHNICAL FEATURES

- Body hardened and ground
- Inserts through-hardened and ground

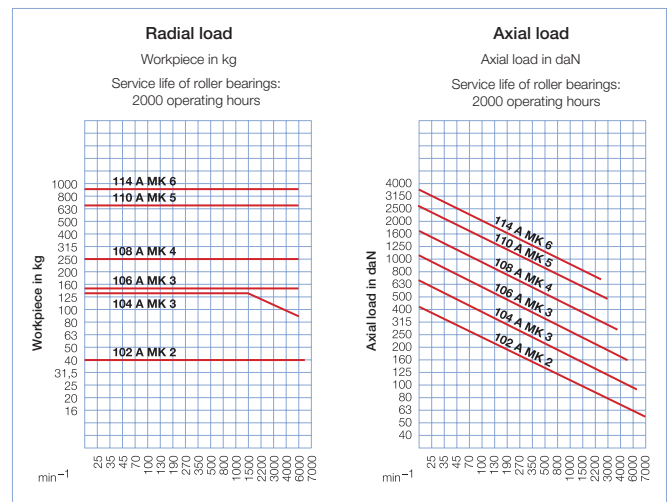
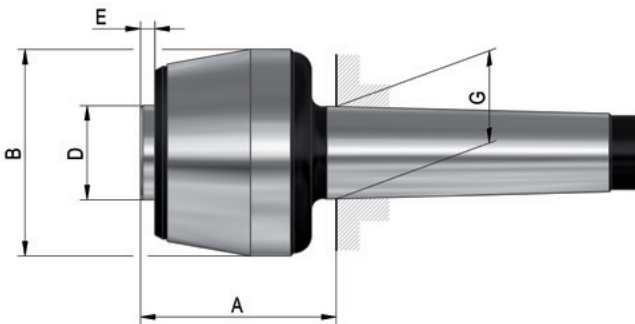
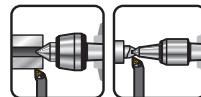

A06

### A Flex - Interchangeable inserts, body hardened and ground

Item no.	061030	061031	061032	061038	061039	061040
Mount MT	2	3	3	4	5	6
Size	102	104	106	108	110	114
A mm	45	48	55	67	85	101
B mm	43	48,5	58,5	68,5	88,5	102,5
D mm	20	22	25	32	40	50
E mm	4	4	5,5	5	6	6
G mm	17,78	23,825	23,825	31,267	44,399	63,348
Concentricity deviation max. mm	0,01	0,01	0,01	0,01	0,01	0,015
Speed max. min <sup>-1</sup>	7000	6300	5000	3800	3000	2600
Workpiece weight max. kg	40	130	150	250	650	900
Weight without inserts	440	750	1100	1900	4400	8600
Weight g	900	1700	2200	3700	8000	-
Spare live spindle	009836	009838	009843	009870	009872	009874

Version with draw-off nut on request

Concentricity deviation measured at internal cone

# Interchangeable inserts

A06  
Interchangeable inserts 60°

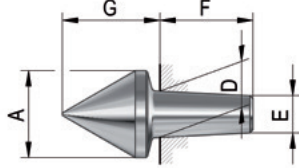

Item no.	Size	A mm	D mm	E mm	F mm	G mm
070725	102	16	7	5,2	18	20
070728	104	20	12	9,6	24	24
070731	106	24	12	9,6	24	27,5
070734	108	28	15	12	30	31,5
070737	110	38	22	18,5	35	43
070740	114	50	28	24	40	54

A06  
Interchangeable inserts 75°

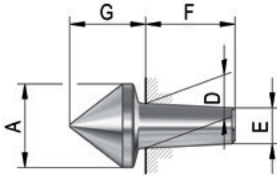

Item no.	Size	A mm	D mm	E mm	F mm	G mm
070726	102	16	7	5,2	18	17
070729	104	20	12	9,6	24	19,5
070732	106	24	12	9,6	24	22,5
070735	108	28	15	12	30	25,5
070738	110	38	22	18,5	35	35
070741	114	50	28	24	40	44

A06  
Interchangeable inserts 90°

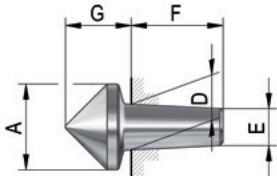

Item no.	Size	A mm	D mm	E mm	F mm	G mm
070727	102	16	7	5,2	18	14,5
070730	104	20	12	9,6	24	16,5
070733	106	24	12	9,6	24	19
070736	108	28	15	12	30	21,5
070739	110	38	22	18,5	35	29
070742	114	50	28	24	40	36

A06  
Interchangeable inserts 60° VL

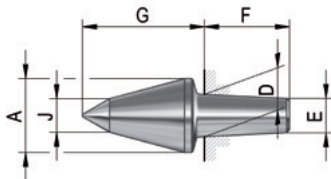

Item no.	Size	A mm	D mm	E mm	F mm	G mm	J mm
070719	102	14	7	5,2	18	25	6
070720	104; 106	18	12	9,6	24	30	8
070721	108	26	15	12	30	43	12
070722	110	32	22	18,5	35	55	13
070723	114	42	28	24	40	70	18,5

A06  
Interchangeable inserts for tubular workpieces 60°

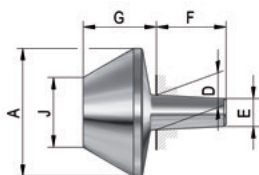

Item no.	Size	A mm	D mm	E mm	F mm	G mm	J mm
070700	102	25	7	5,2	18	21	10
070701	104	35	12	9,6	24	26	15
070702	106	45	12	9,6	24	27	25
070703	108	55	15	12	30	31,5	30
070704	110	70	22	18,5	35	39	40
070705	114	100	28	24	40	52	55

Live centres

# Interchangeable inserts

A06  
Interchangeable inserts A for centerless workpieces 60°

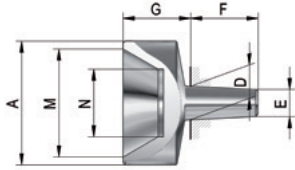

Item no.	Size	A mm	D mm	E mm	F mm	G mm	M mm	N mm
070707	102	25	7	5,2	18	18	20	10
070708	104	35	12	9,6	24	24	30	15
070709	106	45	12	9,6	24	25	40	25
070710	108	55	15	12	30	30	48	30
070711	110	70	22	18,5	35	39	63	40
070712	114	100	28	24	40	52	90	55

A06  
Interchangeable inserts B for centerless workpieces 60°

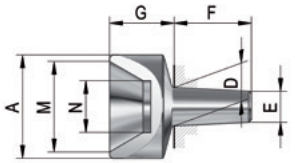

Item no.	Size	A mm	D mm	E mm	F mm	G mm	M mm	N mm
228620	102	16	7	5,2	18	12	12	6
228621	106	22	12	9,6	24	16	18	10
228622	108	40	15	12	30	25	35	20
308632	110	52	22	18,5	35	30	45	30

A06  
Extractor



Item no.	For size
061707	102
061708	104/106/108
061709	110/114

A14  
Mounting sleeve for clamping the live centre in the lathe chuck

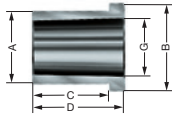

Item no.	MT inside	A mm	B mm	C mm	D mm	G mm
085033	3	32	39	32	40	23,825
085034	4	40	47	42	50	31,267
085035	5	55	62	52	60	44,399
085036	6	75	83	62	70	63,448

# Flex - Interchangeable inserts



## APPLICATION

For counter-clamping workpieces on turning and grinding machines. Especially for individual production of various workpieces through different inserts.

## TYPE

With interchangeable inserts made of wear-resistant tool steel for maximum flexibility. Assortment with different inserts.

## CUSTOMER BENEFITS

- ⊕ Wide range of applications thanks to interchangeable inserts
- ⊕ Quick change of interchangeable inserts

## TECHNICAL FEATURES

- Body hardened and ground
- Inserts through-hardened and ground

## Delivery includes:

- 1 basic body for interchangeable inserts
- 1 extractor for disassembly
- 1 insert 60°, 75°, 90°, 60°VL
- Insert for tubular workpieces 60°
- 2 inserts for centerless workpieces 60°
- Inclusive wooden case

A06

**Complete with all inserts in a sturdy wooden case**

Item no.	061702	061703	061704	061705	061706
Mount MT	2	3	3	4	5
Size	102	104	106	108	110
Workpiece weight max. kg	40	130	150	250	650
Weight g	900	1700	2200	3700	8000

Version with draw-off nut on request

# REVOLVING CENTERING TAPER

For counter-clamping workpieces with large boreholes, (e.g. pipes) on turning and grinding machines, in one set-up. The centre point of the revolving centering taper from RÖHM is hardened and ground for maximum wear resistance.

## REVOLVING CENTERING TAPER



- ⊕ Large clamping range for a wide range of boreholes and centres
- ⊕ Robust precision bearing for high axial and radial loads

## REVOLVING CENTERING TAPER WITH INTERCHANGEABLE INSERTS



- ⊕ Maximum flexibility thanks to use of exchangeable centering taper attachments
- ⊕ Quick change of centering taper attachment in case of wear



### APPLICATION

For counter-clamping workpieces with large boreholes, such as pipes on lathes and grinding machines.

### TYPE

Revolving centering taper in pointed version or cone truncated version.

### CUSTOMER BENEFITS

- ⊕ Large clamping range for a wide range of boreholes and centres
- ⊕ Proven 3-fold bearing for high axial and radial load

### TECHNICAL FEATURES

- Body hardened and ground

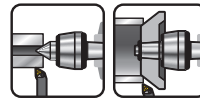

A06

### Revolving centering taper, pointed, as revolving centre for tubular workpieces as well as centre for machining standard workpieces

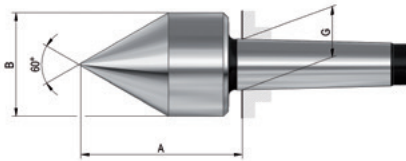

Item no.	Size	Mount MT	A mm	B mm	G mm	Workpiece weight max. kg	Concentricity deviation max. mm	Speed max. min <sup>-1</sup>	Weight g
010613	272	2	61	42	17,78	200	0,01	6000	400
010635	273	3	79	56	23,825	400	0,008	6000	1100
010638	274	4	100	64	31,267	800	0,008	4000	1600
010642	275	5	115,5	78	44,399	1600	0,008	4000	3600
306396	276	6	153	105	63,348	2500	0,008	2500	10000

A06

### Revolving centering taper, cone truncated, 60°

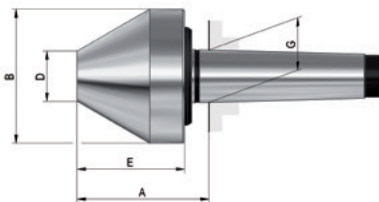

Item no.	Size	Mount MT	A mm	B mm	D mm	E mm	G mm	Work-piece weight max. kg	Concentricity deviation max. mm	Speed max. min <sup>-1</sup>	Weight g
301616	171a	2	65	50	20	52	17,78	200	0,008	6000	1200
301556	172	2	77	80	30	64	17,78	300	0,008	5000	2000
301557	172a	3	77	80	30	64	23,825	400	0,008	5000	2200
221605	173	3	96,5	120	30	83	23,825	600	0,008	4000	4200
301558	172b	4	78,5	80	30	64	31,267	400	0,008	5000	2300
044023	173a	4	98	120	30	83	31,267	800	0,008	4000	4500
090483	173b	5	99	120	30	83	44,399	800	0,008	4000	5300

A06

### Revolving centering taper, cone truncated, 75°

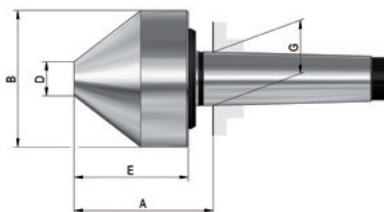

Item no.	Size	Mount MT	A mm	B mm	D mm	E mm	G mm	Work-piece weight max. kg	Concentricity deviation max. mm	Speed max. min <sup>-1</sup>	Weight g
301559	172	2	80	80	20	67	17,78	300	0,008	5000	2000
301560	172a	3	80	80	20	67	23,825	400	0,008	5000	2000
062211	173	3	85,5	120	30	72	23,825	600	0,008	4000	4200
301561	172b	4	81,5	80	20	67	31,267	400	0,008	5000	2400
062224	173a	4	87	120	30	72	31,267	800	0,008	4000	4300
062299	174	4	107	170	50	90	31,267	1200	0,01	2800	9700
062232	173b	5	88	120	30	72	44,399	800	0,008	4000	5100
063614	174a	5	106	170	50	90	44,399	1600	0,01	2800	10600
063662	175	5	146,5	250	75	130	44,399	2000	0,01	2200	34000
063633	174b	6	107,5	170	50	90	63,348	1600	0,01	2800	13300
063656	175a	6	148	250	75	130	63,348	2000	0,01	2200	37000
063680	176	6	184	350	120	168	63,348	4000	0,015	1200	82000



**APPLICATION**

For counter-clamping workpieces with large boreholes, such as pipes on lathes and grinding machines.

**TYPE**

With interchangeable centering taper attachments. Optionally with draw-off nut or fixed shaft.

**CUSTOMER BENEFITS**

- ⊕ High flexibility thanks to interchangeable centering taper attachments
- ⊕ Quick change of interchangeable centering taper attachments

**TECHNICAL FEATURES**

- Body hardened and ground
- Centering taper insert hardened and ground



A06  
**Revolving centering taper**

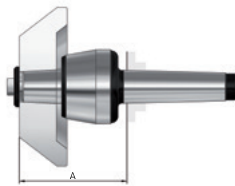

Item no.	Size	Mount MT	A mm	Workpiece weight max. kg	Concentricity deviation max. mm	Speed max. min <sup>-1</sup>	Weight g
304562	108	4	103	800	0,005	3800	2200
304563	110	5	128	1600	0,005	3000	4800
304564	114	6	159	3000	0,005	2600	12000

With fastening screw and disc, without centering taper attachment  
Concentricity deviation measured at conical mount

A06  
**Revolving centering tapers with draw-off nut, for high load**

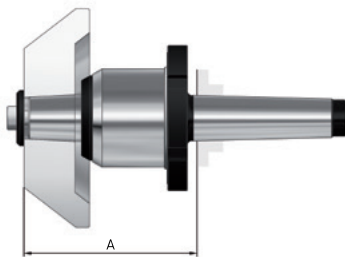

Item no.	Size	Mount MT	A mm	Workpiece weight max. kg	Concentricity deviation max. mm	Speed max. min <sup>-1</sup>	Weight g
304583	494	4	118	1000	0,005	7000	3200
304584	495	5	140	2000	0,005	6000	6500
304585	496	6	168	3500	0,005	4800	13500

With fastening screw and disc, without centering taper attachment  
Concentricity deviation measured at conical mount

A07  
**Fixed shafts**



Item no.	Mount MT	A mm	Workpiece weight max. kg	Concentricity deviation max. mm	Weight g
304580	4	45	2000	0,003	800
304581	5	60	4800	0,003	2000
304582	6	70	12000	0,003	5500

With fastening screw and disc, without centering taper attachment  
Version with draw-off nut on request  
Concentricity deviation measured at conical mount



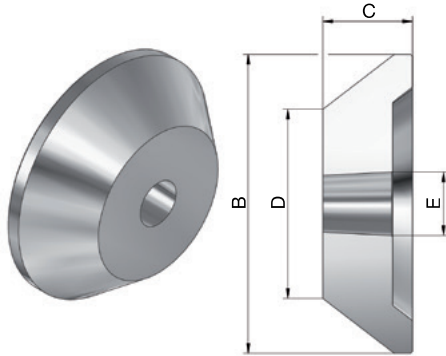

Item no.	Size	for MT	B mm	C mm	D mm	E mm	Weight g
304565 <sup>1)</sup>	1	4	60	68	5	32	900
304566	2	4	100	45	45	32	1500
304567	3	4	150	45	95	32	4100
304568	4	4	200	45	145	32	6000
304569	5	4	250	45	195	32	8500
304570	1	5	100	43	45	40	1500
304571	2	5	150	43	95	40	4400
304572	3	5	200	43	145	40	6100
304573	4	5	250	43	195	40	8100
304574	5	5	300	43	245	40	11600
304575	1	6	150	54	95	50	3000
304576	2	6	200	54	145	50	8100
304577	3	6	250	54	195	50	11100
304578	4	6	300	54	245	50	14000
304579	5	6	350	54	295	50	18800

<sup>1)</sup> Without fixing by screw and washer

# SOLID CENTRES

Revolving centering taper MZK

Optimally suited for the counter-clamping of workpieces on turning machines with tailstock bearing and grinding machines in one set-up as well as for measurement technology. The solid centres are hardened and ground.

## ADVANTAGES AT A GLANCE

- ⊕ High wear resistance thanks to tool steel / carbide insert
- ⊕ High load capacity and rigidity thanks to compact design
- ⊕ Concentricity deviation of up to 0.005 mm

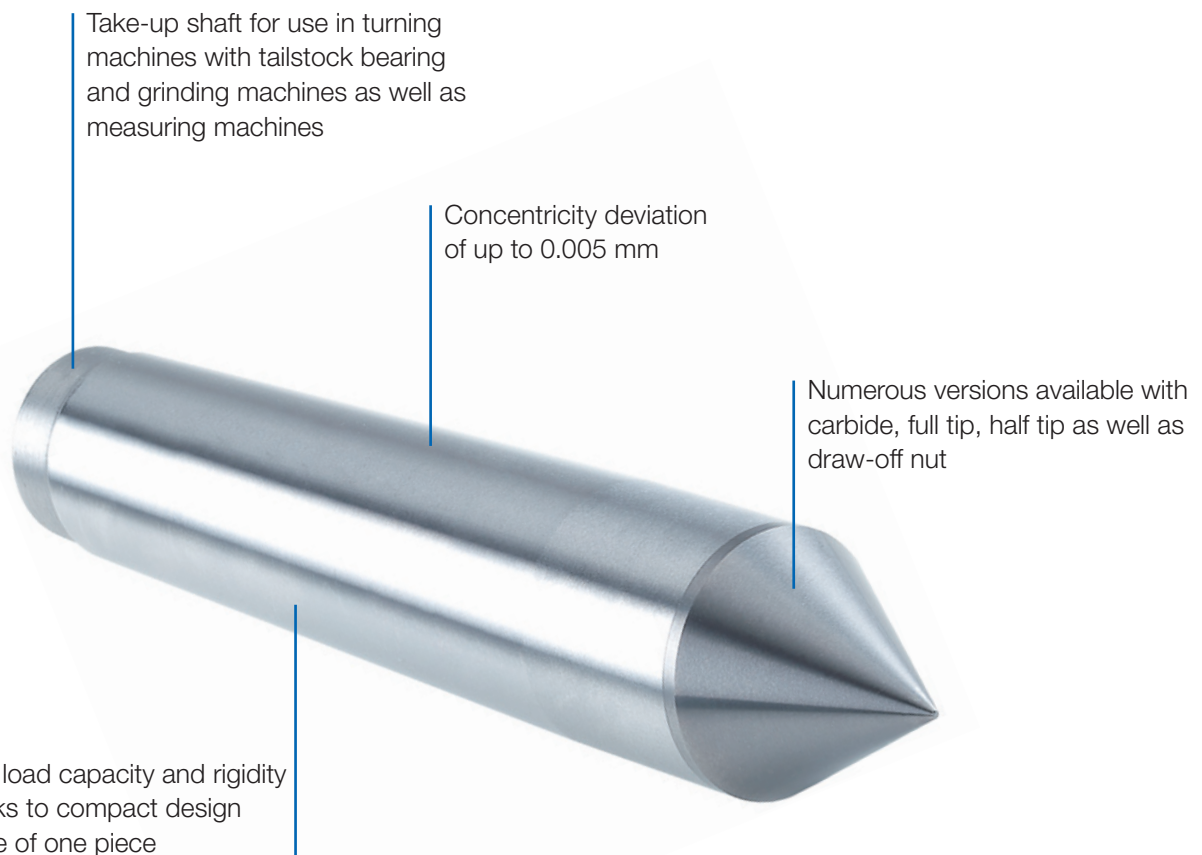



### APPLICATION

For counter-clamping workpieces on lathes with tailstock bearing and grinding machines.

### TYPE

Designs with concentricity of 0.003 mm or higher are available on request.

### CUSTOMER BENEFITS

- ⊕ High wear resistance thanks to tool steel / carbide insert
- ⊕ High load capacity and rigidity since tips are one piece

### TECHNICAL FEATURES

- Solid centres are hardened and ground

A07  
DIN 806, full point, ground, with full carbide tip

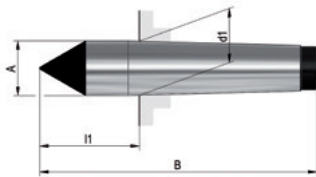

Item no.	Mount MT	A mm	B mm	d1 mm	l1 mm	Weight g
326786	2	18	100	17,78	36	175
306402	3	24,1	125	23,825	44	400
221398	4	31,6	160	31,267	57,5	855
326816	5	44,7	200	44,399	70,5	2160

A07  
DIN 806, full point, ground, with carbide insert and regrinding line

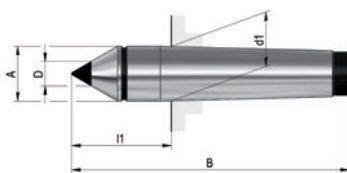

Item no.	Mount MT	A mm	B mm	D mm	d1 mm	l1 mm	Weight g
017171	2	18	100	7	17,78	36	155
017172	3	24,1	125	11	23,825	44	360
017173	4	31,6	160	14	31,267	57,5	770
017174	5	44,7	200	18	44,399	70,5	1950

A07  
DIN 806, full point, material: tool steel

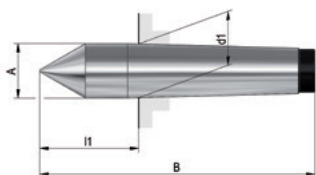

Item no.	Mount MT	A mm	B mm	d1 mm	l1 mm	Weight g
013706	0	9,2	70	9,045	20	30
013707	1	12,2	80	12,065	26,5	60
013709	2	18	100	17,78	36	150
013711	3	24,1	125	23,825	44	340
013712	4	31,6	160	31,267	57,5	760
013715	5	44,7	200	44,399	70,5	1920
013718	6	63,8	270	63,348	88	5200

# FZS

A07  
Similar DIN 807, full point, with draw-off nut and SW, material: tool steel

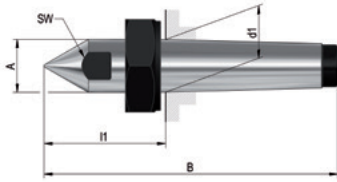

Item no.	Mount MT	A mm	B mm	C	d1 mm	l1 mm	Key-width SW	Weight g
005654	3	24,1	138	M27x1,5	23,825	57	19	580
005357	4	31,6	175	M36x1,5	31,267	72,5	27	800
005381	5	44,7	217	M48x1,5	44,399	87,5	36	2900
005426	6	63,8	290	M68x1,5	63,348	108	55	7200

A07  
Similar DIN 807, full point, with draw-off nut and SW, with extended centre point, material: tool steel

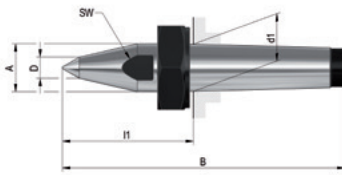

Item no.	Mount MT	A mm	B mm	C	D mm	d1 mm	l1 mm	Key-width SW	Weight g
249576	3	24,1	148	M27x1,5	10	23,825	67	19	600
249577	4	31,6	186,5	M36x1,5	14	31,267	84	27	1285
249578	5	44,7	242	M48x1,5	16	44,399	112	36	3000
249579	6	63,8	330	M68x1,5	20	63,348	148	55	7900

A07  
Draw-off nut



Item no.	C	H mm	Key-width SW	Weight
005656	M27x1,5	17,5	41	110
005359	M36x1,5	21	55	240
005383	M48x1,5	23	75	480
005428	M68x1,5	25,5	100	900

A07  
DIN 806, half point, ground, with carbide insert

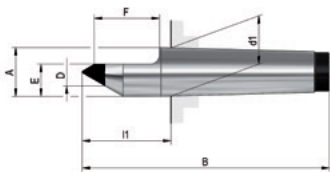

Item no.	Mount MT	A mm	B mm	D mm	E mm	F mm	d1 mm	l1 mm	Weight g
027439	2	18	100	7	11	30	17,78	36	150
027440	3	24,1	125	11	15	38	23,825	44	335
026571	4	31,6	160	14	21	50	31,267	57,5	750
027441	5	44,7	200	18	29,4	63	44,399	70,5	1830

A07  
DIN 806, half point, material: tool steel

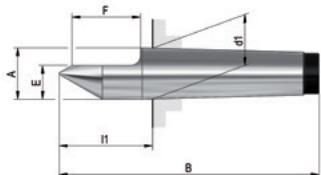

Item no.	Mount MT	A mm	B mm	E mm	F mm	d1 mm	l1 mm	Weight g
013868	2	18	100	11	30	17,78	36	145
013870	3	24,1	125	15	38	23,825	44	310
013871	4	31,6	160	21	50	31,267	57,5	710
013997	5	44,7	200	29,4	63	44,399	70,5	1925



# Notes

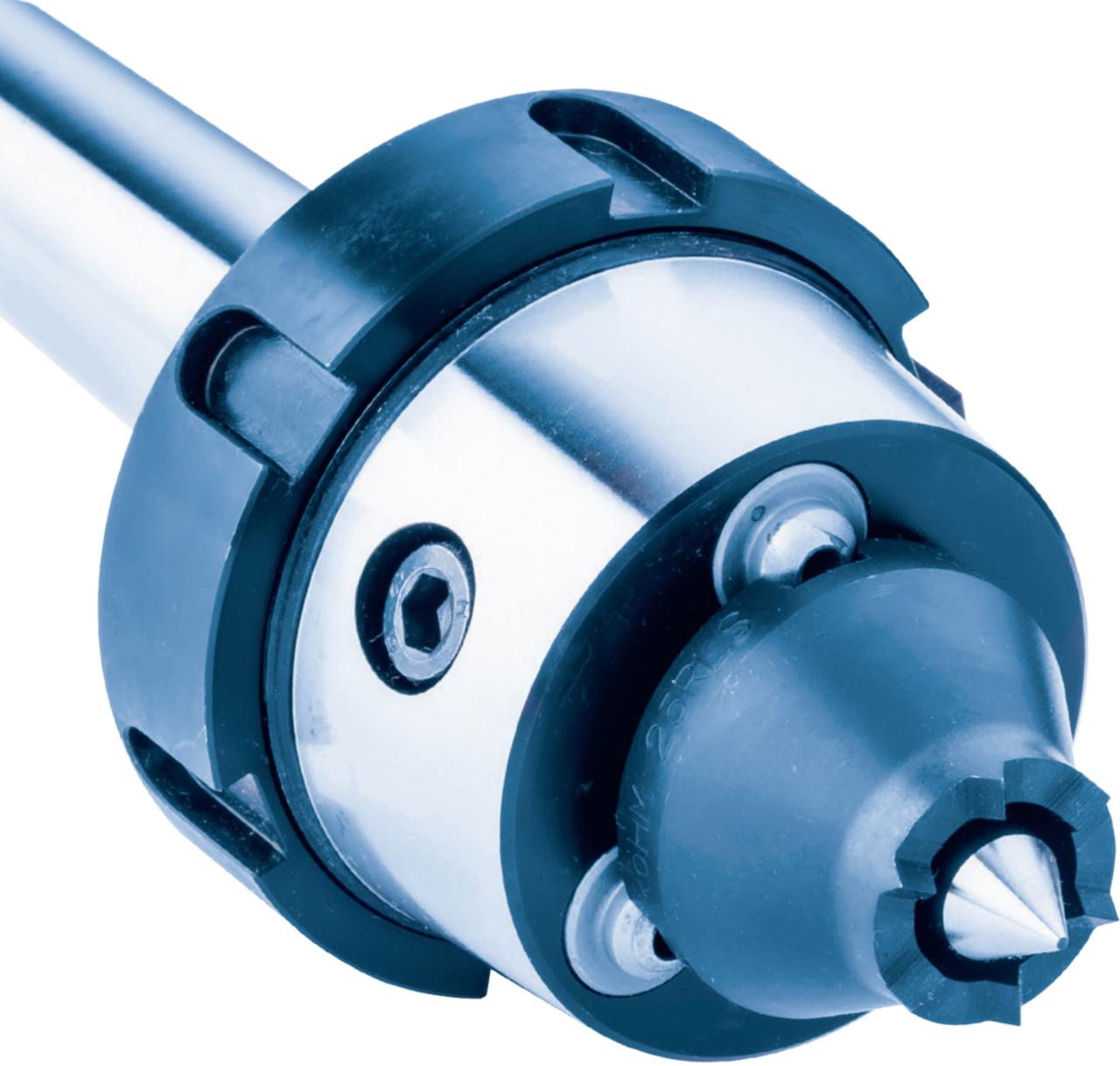

## RADIALLY BACKLASH-FREE - TURNING AND MILLING IN ONE SET-UP

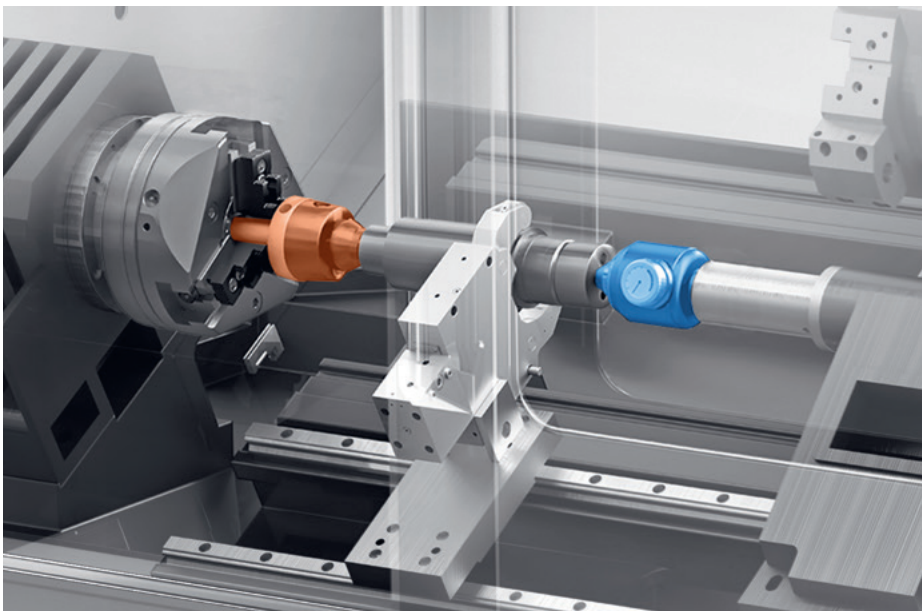

The driver disc is supported on one level made of three bolt heads. The bolts transfer the torque to the driver disc. This happens without any play due to the design of the bolt heads and pockets on the bottom of the driver disc. As a result, you can also machine the workpiece clamped in the CoAE with the milling spindle at any time. The workpiece remains. For the highest precision.

# CONSTANT FACE DRIVERS

The Constant face drivers of RÖHM are optimally suited for the rational turning and milling of workpieces over their entire length. The mount has no radial play. Due to the modular construction, it is possible to use different centers as well as different driver discs with a single face driver and that way machine a great variety of geometries.

## ADVANTAGES AT A GLANCE

- ⊕ Radially backlash-free and can be used in clockwise and counterclockwise rotation
- ⊕ High concentricity thanks to narrow tolerances
- ⊕ Constant clamping force thanks to mechanical or hydraulic pressure compensation, even for uneven workpiece faces

Various take-up types for every application or for all common machine types

Axially adjustable spring package for flexible adaptation of the centering force

Centre point for maximum concentricity of up to 0.01 mm

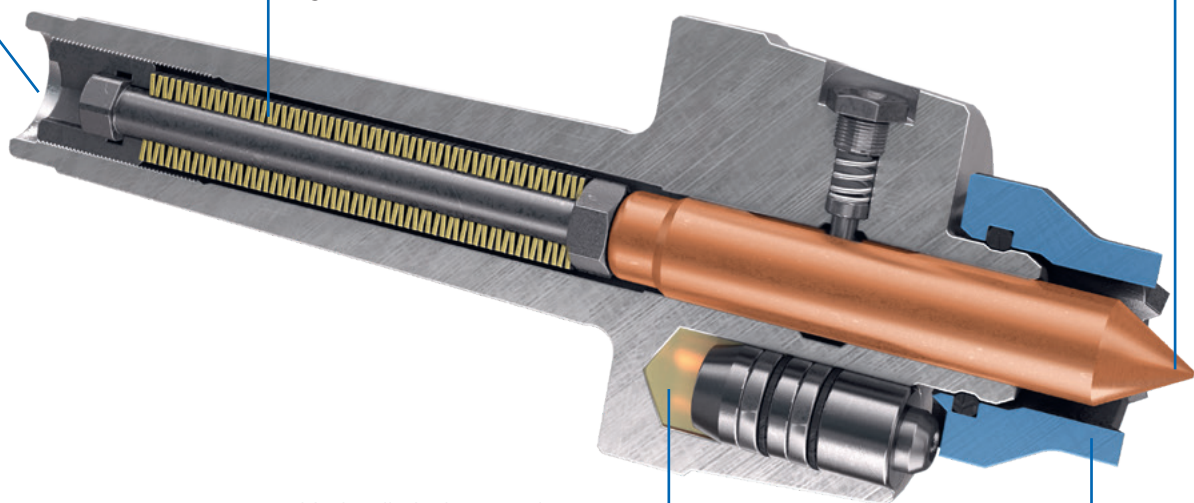

Hydraulic bolt mounting compensates for skewing of the driver disc caused by uneven or non-perpendicular end face of the workpiece.

Quickly exchangeable driver disc and centre point for maximum flexibility

# Operation guide



TYPE	CoAE	CoK-AE
<b>Machining</b>	Turning and milling in one set-up  <b>Patented compensating driving disc, radially backlash-free</b>  For the rational <b>turning and milling</b> of workpieces on its entire length without reclamping with maximum precision.	Turning on automatic machining equipment  <b>Radially backlash-free</b>  For machining workpieces which are highly unbalanced, very heavy, for high chip removal or for irregular cutting.
<b>Concentricity deviation max.</b>	Up to 0.015 mm measured at the center point	Up to 0.01 mm measured at the center point
<b>Actuation</b>	not power-operated	power-operated
<b>Pressure compensation</b>	hydraulic / mechanical	mechanical
<b>Workpiece weight</b>	up to 100 kg	up to 350 kg
<b>Centre point</b>	resilient	fixed
<b>Clamping-Ø</b>	8 - 80 mm	8 - 80 mm
<b>Adapter</b>	with morse taper / with morse taper and draw-off nut / with cylindrical shank for clamping in lathe chucks / with short taper / in flange type	with centring mount for adapter plate
<b>Page</b>	2040	2050

TYPE	CoM	CoB
<b>Machining</b>	Turning  For clamping large and heavy workpieces, as well as workpieces with extremely uneven faces	Turning  For clamping large and heavy workpieces, as well as workpieces with extremely uneven faces
<b>Concentricity deviation max.</b>	0.015 mm	0.015 mm
<b>Actuation</b>	not power-operated	not power-operated
<b>Pressure compensation</b>	mechanical	hydraulic
<b>Workpiece weight</b>	up to 500 kg	up to 500 kg / 1.000 kg
<b>Centre point</b>	resilient, axially adjustable	resilient, axially adjustable
<b>Clamping-Ø</b>	50 - 250 mm	63 - 160 mm
<b>Adapter</b>	with morse taper / with short taper	with morse taper / with short taper
<b>Page</b>	2054	2054





# CoAE - turning and milling

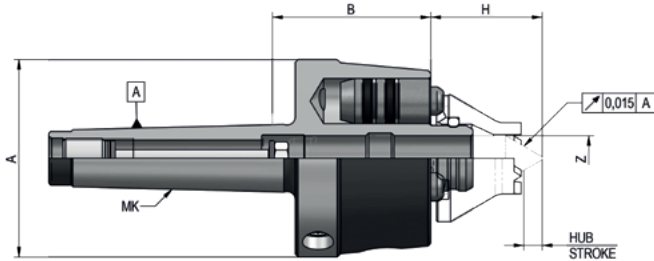

### APPLICATION

For the rational **turning and milling** of workpieces on its entire length without reclamping with maximum precision. Can be used in clockwise and counterclockwise rotation.

### TYPE

Basic body with morse taper and hydraulic pressure compensation. Clamping circuit Ø 8-80 mm. Workpiece weight max. 100 kg.

### CUSTOMER BENEFITS

- ⊕ For **turning and milling** in one set-up
- ⊕ Compensating driving disc, radially backlash-free
- ⊕ Maximum concentricity deviation of 0.015 mm for maximum precision
- ⊕ Stable and constant workpiece length stop on the front side thanks to resilient centre point
- ⊕ Maximum flexibility thanks to universal exchange of driving disc and centre point

### TECHNICAL FEATURES

- Guide value for axially permissible total load on 3 support pistons: 20.000 N

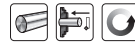

A14

#### Basic body with morse taper (basic body without driving disc and center), hydraulic

Item no.	MT	A mm	B mm	H mm	Z mm	Centres stroke mm	Weight approx. g
1340429	3	70	54,5	max. 45 min. 26	16	10	1600
1340430	4	70	56,5	max. 45 min. 26	16	15	1800
1340431	5	70	56,5	max. 45 min. 26	16	15	2800
1340432	6	70	56,5	max. 45 min. 26	16	15	4400

### APPLICATION

For the rational **turning and milling** of workpieces on its entire length without reclamping with maximum precision. Can be used in clockwise and counterclockwise rotation.

### TYPE

Basic body with morse taper, draw-off nut and hydraulic pressure compensation. Clamping circuit Ø 8-80 mm. Workpiece weight max. 100 kg.

### CUSTOMER BENEFITS

- ⊕ For **turning and milling** in one set-up
- ⊕ Compensating driving disc, radially backlash-free
- ⊕ Maximum concentricity deviation of 0.015 mm for maximum precision
- ⊕ Stable and constant workpiece length stop on the front side thanks to resilient centre point
- ⊕ Maximum flexibility thanks to universal exchange of driving disc and centre point

### TECHNICAL FEATURES

- Guide value for axially permissible total load on 3 support pistons: 20.000 N

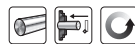

A14

#### Basic body with morse taper, with draw-off nut (basic body without driving disc and centre), hydraulic

Item no.	MT	A mm	B mm	H mm	Z mm	Centres stroke mm	Weight approx. g
1340433	3	82	54,5	max. 45 min. 26	16	10	1800
1340434	4	82	56,5	max. 45 min. 26	16	15	2200
1340435	5	82	56,5	max. 45 min. 26	16	15	3000
1340436	6	82	56,5	max. 45 min. 26	16	15	4600

# CoAE - turning and milling

Constant face driver  
CoAE

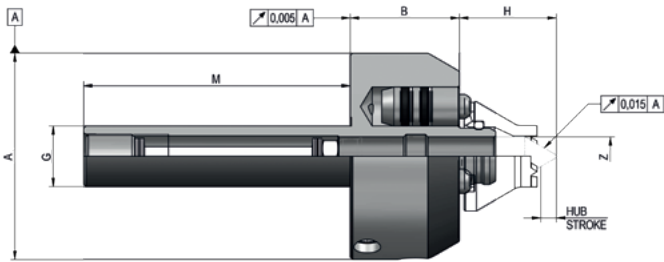

### APPLICATION

For the rational **turning and milling** of workpieces on its entire length without reclamping with maximum precision. Can be used in clockwise and counterclockwise rotation.

### TYPE

Basic body with cylindrical shank and hydraulic pressure compensation.. Clamping circuit  $\varnothing$  8-80 mm. Workpiece weight max. 100 kg.

### CUSTOMER BENEFITS

- Ⓢ For **turning and milling** in one set-up
- Ⓢ Compensating driving disc, radially backlash-free
- Ⓢ Maximum concentricity deviation of 0.015 mm for maximum precision
- Ⓢ Stable and constant workpiece length stop on the front side thanks to resilient centre point
- Ⓢ Maximum flexibility thanks to universal exchange of driving disc and centre point

### TECHNICAL FEATURES

- Guide value for axially permissible total load on 3 support pistons: 20.000 N

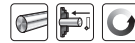

A14  
Basic body with cylindrical shank for clamping in lathe chucks, with spring package (basic body without driving disc and centre), hydraulic

Item no.	A mm	B mm	G mm	H mm	M mm	Z mm	Centres stroke mm	Weight approx. g
1341541	70	48	25**	max. 45 min. 26	87,5	16	10	1600
1341542	70	48	32**	max. 45 min. 26	111	16	15	1800
1340437	85*	45	25	max. 45 min. 26	110	16	15	2300

\* Mounting diameter as shown in drawing  
\*\* Mounting diameter not shown

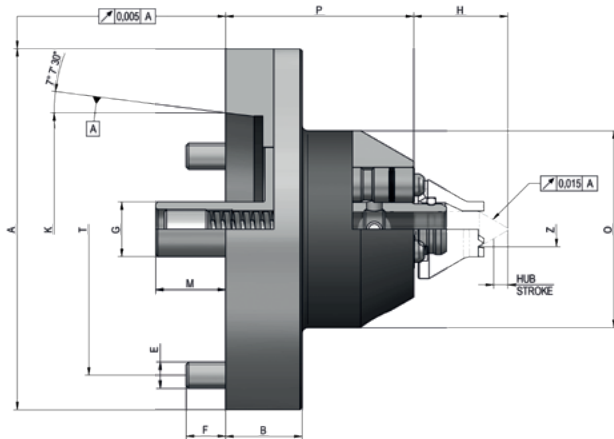

### APPLICATION

For the rational **turning and milling** of workpieces on its entire length without reclamping with maximum precision. Can be used in clockwise and counterclockwise rotation.

### TYPE

Basic body with short taper and mechanical pressure compensation. Clamping circuit  $\varnothing$  8-80 mm. Workpiece weight max. 100 kg.

### CUSTOMER BENEFITS

- Ⓢ For **turning and milling** in one set-up
- Ⓢ Compensating driving disc, radially backlash-free
- Ⓢ Maximum concentricity deviation of 0.015 mm for maximum precision
- Ⓢ Stable and constant workpiece length stop on the front side thanks to resilient centre point
- Ⓢ Maximum flexibility thanks to universal exchange of driving disc and centre point

### TECHNICAL FEATURES

- Guide value for axially permissible total load on 3 support pistons: 20.000 N



A14  
Basic body with short taper ISO 702-1 (DIN 55026), with spring package (basic body without driving disc and center), mechanical

Item no.	Short-taper	A mm	B mm	E	F mm	G mm	H mm	K mm	M mm	O mm	P mm	T mm	Z mm	Centres stroke mm	Weight approx. g
1340439	5	133	24,5	M10	15	25	max. 45 min. 26	82,563	32	90	86	104,8	16	11	6500
1340440	6	165	35	M12	18	25	max. 45 min. 26	106,375	32	90	86	133,4	16	11	7000
1340441	8	210	40	M16	23	25	max. 45 min. 26	139,719	32	90	86	171,4	16	11	8100

# CoAE - turning and milling

Constant face driver  
CoAE

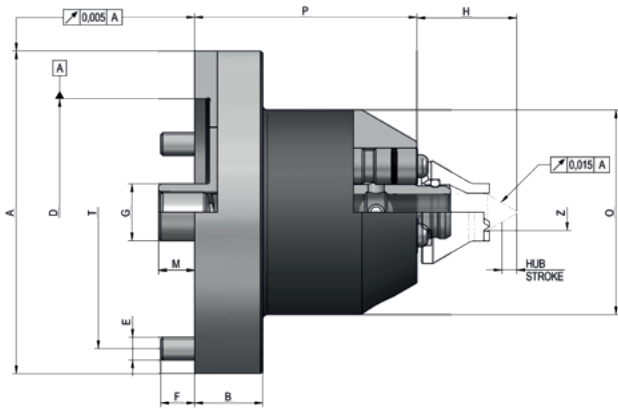

### APPLICATION

For the rational **turning and milling** of workpieces on its entire length without reclamping with maximum precision. Can be used in clockwise and counterclockwise rotation.

### TYPE

Basic body with centring mount and hydraulic pressure compensation.. Clamping circuit Ø 8-80 mm. Workpiece weight max. 100 kg.

### CUSTOMER BENEFITS

- ⊕ For **turning and milling** in one set-up
- ⊕ Compensating driving disc, radially backlash-free
- ⊕ Maximum concentricity deviation of 0.015 mm for maximum precision
- ⊕ Stable and constant workpiece length stop on the front side thanks to resilient centre point
- ⊕ Maximum flexibility thanks to universal exchange of driving disc and centre point

### TECHNICAL FEATURES

- Guide value for axially permissible total load on 3 support pistons: 20.000 N

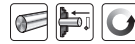

A14

**Basic body flange type, with spring set (basic body without driving disc and center), hydraulic**

Item no.	A mm	B mm	D mm	E	F mm	G mm	H mm	M mm	O mm	P mm	T mm	Z mm	Centres stroke mm	Weight approx. g
1340442	142	30	100	M10	15	25	max. 45 min. 26	61	90	98	120	16	15	7300

# Adapter plate CoAE

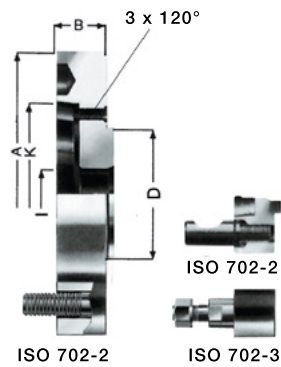

Constant face driver  
CoAE

A14  
Adapter plate short taper

Item no.	Design	Taper	A mm	B mm	D mm	I mm	K mm	Weight approx. g
088485	ISO 702-1	5	140	30	100	38	82,563	3100
088486	ISO 702-1	6	167	35	100	38	106,39	4800
088487	ISO 702-1	8	216	40	100	38	139,735	8700
088488	ISO 702-1	11	280	45	100	38	196,885	17000
088480	ISO 702-3	5	140	30	100	38	82,563	3100
088481	ISO 702-3	6	167	35	100	38	106,39	4800
088482	ISO 702-3	8	216	40	100	38	139,735	8700
088483	ISO 702-3	11	280	45	100	38	196,885	17000
088495	ISO 702-2	5	140	30	100	38	82,563	3100
088496	ISO 702-2	6	167	35	100	38	106,39	4800
088497	ISO 702-2	8	216	40	100	38	139,735	8700
088498	ISO 702-2	11	280	45	100	38	196,885	17000

# Accessories CoAE

Accessories face drivers CoAE

A14

**Driving discs, with interchangeable carbide driving plates 6 x 3.2, right- and left-hand rotation, max. workpiece hardness 40 HRC**

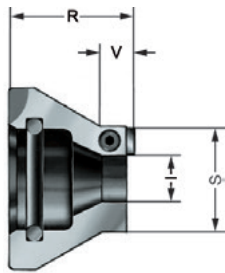

Item no.	Clamping circuit Ø S mm	Approx. turning range	l mm	R mm	V mm	Assoc. centre point Ø Y mm	Axial load max. N
1341624	20 H	21-40	7	30	5	6	8000
1341625	25 H	26-50	11	30	8	10	8000
1341626	32 H	33-64	17,5	30	10	16	8000

A14

**Driving discs, with interchangeable carbide driving plates 6 x 3.2, right-hand rotation, max. workpiece hardness 40 HRC**

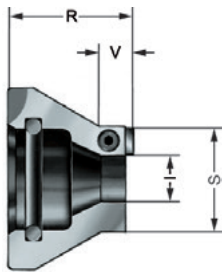

Item no.	Clamping circuit Ø S mm	Approx. turning range	l mm	R mm	V mm	Assoc. centre point Ø Y mm	Axial load max. N
1341628	20 H	21-40	7	30	5	6	8000
1341629	25 H	26-50	11	30	8	10	8000
1341630	32 H	33-64	17,5	30	10	16	8000

A14

**Driving discs, with interchangeable carbide driving plates 6 x 3.2, left-hand rotation, max. workpiece hardness 40 HRC**

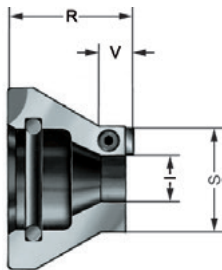

Item no.	Clamping circuit Ø S mm	Approx. turning range	l mm	R mm	V mm	Assoc. centre point Ø Y mm	Axial load max. N
1341631	20 H	21-40	7	30	5	6	8000
1341632	25 H	26-50	11	30	8	10	8000
1341633	32 H	33-64	17,5	30	10	16	8000

A14

**Driving discs, toothed, right- and left-hand rotation, max. workpiece hardness 35 HRC**

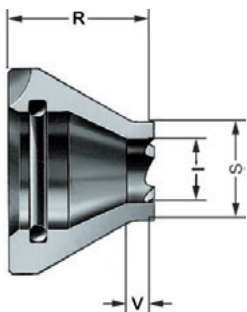

Item no.	Clamping circuit Ø S mm	Approx. turning range	l mm	R mm	V mm	Assoc. centre point Ø Y mm	Axial load max. N
1341603	8	9-16	4,5	38	4	4	4000
1341604	10	11-20	4,5	38	4	4	6000
1341605	12	13-24	7	36	4	6	6000
1341606	16	17-32	11	33	4	10	6000
1341607	20	21-40	13	30	4	12	8000
1341608	25	26-50	17	30	8	16	10000
1341609	32	33-64	22	30	10	16	12500

Mitnehmer-Scheiben mit Hartmetall-Verzahnung auf Anfrage

# Accessories CoAE

A14

**Driving discs, toothed, right-hand rotation, max. workpiece hardness 35 HRC**

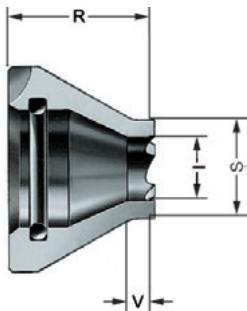

Item no.	Clamping circuit Ø S mm	Approx. turning range	l mm	R mm	V mm	Assoc. centre point Ø Y mm	Axial load max. N
1341610	8	9-16	4,5	38	4	4	4000
1341611	10	11-20	4,5	38	4	4	6000
1341612	12	13-24	7	36	4	6	6000
1341613	16	17-32	11	33	4	10	6000
1341614	20	21-40	13	30	4	12	8000
1341615	25	26-50	17	30	8	16	10000
1341616	32	33-64	22	30	10	16	12500

Driving discs with carbide tothing, friction lining or diamond grain on request

Accessories face drivers CoAE

A14

**Driving discs, toothed, left-hand rotation, max. workpiece hardness 35 HRC**

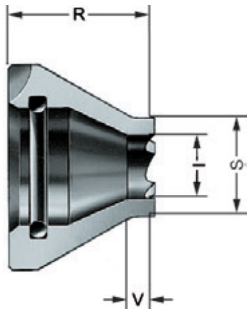

Item no.	Clamping circuit Ø S mm	Approx. turning range	l mm	R mm	V mm	Assoc. centre point Ø Y mm	Axial load max. N
1341617	8	9-16	4,5	38	4	4	4000
1341618	10	11-20	4,5	38	4	4	6000
1341619	12	13-24	7	36	4	6	6000
1341620	16	17-32	11	33	4	10	6000
1341621	20	21-40	13	30	4	12	8000
1341622	25	26-50	17	30	8	16	10000
1341623	32	33-64	22	30	10	16	12500

Driving discs with carbide tothing, friction lining or diamond grain on request

A14

**Driving discs, with interchangeable carbide driving plates 9.5 x 3.2, right- and left-hand rotation, max. workpiece hardness 40 HRC**

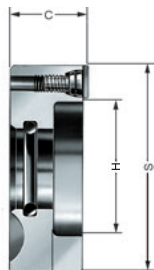

Item no.	Clamping circuit Ø S mm	Approx. turning range	H mm	C mm	Assoc. centre point Ø Y mm	Axial load max. N
1341627	40	41-80	20	24	16	14000
1341635	50	51-100	28	24	16	14000
1341636	63	64-126	41	24	16	14000
1341637	80	81-160	58	24	16	14000

A14

**Driving discs, with interchangeable carbide driving plates 9.5 x 3.2, right-hand rotation, max. workpiece hardness 40 HRC**

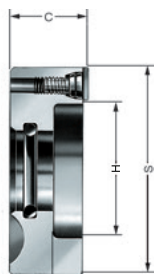

Item no.	Clamping circuit Ø S mm	Approx. turning range	H mm	C mm	Assoc. centre point Ø Y mm	Axial load max. N
1341638	40	41-80	20	24	16	14000
1341639	50	51-100	28	24	16	14000
1341640	63	64-126	41	24	16	14000
1341641	80	81-160	58	24	16	14000

# Accessories CoAE

Accessories face drivers CoAE

A14

Driving discs, with interchangeable carbide driving plates 9.5 x 3.2, left-hand rotation, max. workpiece hardness 40 HRC

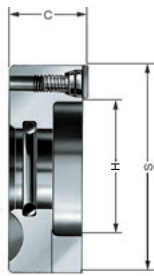

Item no.	Clamping circuit Ø S mm	Approx. turning range	H mm	C mm	Assoc. centre point Ø Y mm	Axial load max. N
1341642	40	41-80	20	24	16	14000
1341643	50	51-100	28	24	16	14000
1341644	63	64-126	41	24	16	14000
1341645	80	81-160	58	24	16	14000

A14

Centres CoAE

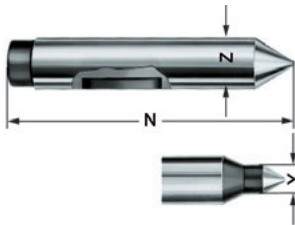

Item no.	Clamping circuit Ø S mm	N mm	Y mm	Z mm
1341941	8-10	90	4	16
1341942	12	90	6	16
1341943	16	90	10	16
1341944	20	90	12	16
1341945	25-80	90	16	16
1342112	25-80	110	16	16

A14

Centres CoAE

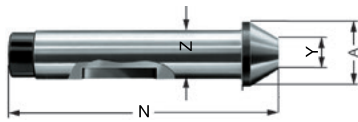

Item no.	Taper Ø		N mm	Z mm	Weight approx. g
	A mm	Y mm			
1341946	20	10	90	16	136
1341947	26	14	90	16	153
1341948	34	22	90	16	190
1341949	40	28	90	16	210
1341950	48	36	90	16	250
1341951	56	44	90	16	312

A14

Carbide driving plates, right- and left-hand rotation



Item no.	Size	Clamping circuit Ø mm
088970	6x3,2	20-32
087931	9,5x3,2	40-80

A14

Carbide driving plates, right- or left-hand rotation



Item no.	Size	Clamping circuit Ø mm
088810	6x3,2	20-32
088209	9,5x3,2	40-80

A14

Mounting sleeve for clamping the face driver in the lathe chuck

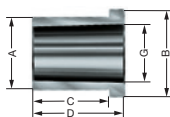

Item no.	MT inside	A mm	B mm	C mm	D mm	G mm
085033	3	32	39	32	40	23,825
085034	4	40	47	42	50	31,267
085035	5	55	62	52	60	44,399
085036	6	75	83	62	70	63,448



# Accessories CoAE

C15  
Threaded pin



Item no.	Size	Clamping circuit Ø mm
234695	M 4 x 6	20
048205	M 5 x 8	25-32
088205	M 5 x 8	40-80

C15  
O-ring



Item no.	Size
006252	21,82x3,53

A14  
RÖHM slide rule for determining the axial tailstock force



Item no.
088230

C15  
Semifluid grease F25 for face driver



Item no.	Design	Contents
036397	Dose	1000 g

## CoAE - product ranges

A14  
Basic equipment in a carton, hydraulic pressure compensation, clamping dia. 12 + 32 mm, turning range 13-64 mm  
Included in delivery: 1x basic body, 2x driving discs (clamping circuit-Ø 12, 32), 2x centre points (centering Ø 6, 16)



Item no.	Mount	right-hand rotation	left-hand rotation	With draw-off nut.	Weight approx. g
1341543	MT3	•			2100
1341544	MT3	•		•	2400
1341545	MT3		•		2100
1341546	MT3		•	•	2400
1341547	MT4	•			2400
1341548	MT4	•		•	2700
1341549	MT4		•		2400
1341550	MT4		•	•	2700
1341551	MT5	•			3300
1341552	MT5	•		•	3600
1341553	MT5		•		3300
1341554	MT5		•	•	3600
1341555	MT6	•			4900
1341556	MT6	•		•	5200
1341557	MT6		•		4900
1341558	MT6		•	•	5200
1341559	ZA25	•			2100
1341560	ZA25		•		2100
1341561	ZA32	•			2400
1341562	ZA32		•		2400

Accessories face drivers CoAE

# CoAE - product ranges

A14

Small assortment in wooden box, hydraulic pressure compensation, clamping dia. 12-50 mm, turning range 13-100 mm  
 Included in delivery: 1x basic body, 4x driving discs (clamping circuit Ø 12, 20, 32, 50), 2x centre points (centering Ø 6, 12)



Constant face driver  
CoAE

Item no.	Mount	right-hand rotation	left-hand rotation	right-hand and left-hand rotation	With draw-off nut.	Weight approx. g
1341563	MT3	•				3900
1341564	MT3	•			•	4200
1341565	MT3		•			3900
1341566	MT3		•		•	4200
1381611	MT3			•		3900
1382283	MT3			•	•	4200
1341567	MT4	•				4300
1341568	MT4	•			•	4600
1341569	MT4		•			4300
1341570	MT4		•		•	4600
1381612	MT4			•		4300
1382284	MT4			•	•	4600
1341571	MT5	•				4900
1341572	MT5	•			•	5200
1341573	MT5		•			4900
1341574	MT5		•		•	5200
1381613	MT5			•		4900
1382285	MT5			•	•	5200
1341575	MT6	•				6600
1341576	MT6	•			•	6800
1341577	MT6		•			6600
1341578	MT6		•		•	6800
1381614	MT6			•		6600
1382286	MT6			•	•	6800
1341579	ZA25	•				3900
1341580	ZA25		•			3900
1381609	ZA25			•		4300
1341581	ZA32	•				4300
1341582	ZA32		•			4300
1381610	ZA32			•		4300

A14

Large assortment in wooden box, hydraulic pressure compensation, clamping dia. 10-80 mm, turning range 11-160 mm  
 Included in delivery: 1x basic body, 10x driving discs (clamping circuit Ø 10, 12, 16, 20, 25, 32, 40, 50, 63, 80), 5x centre points (centering Ø 4, 6, 10, 12, 16)  
 1x RÖHM slide rule for determining the axial tailstock force



Item no.	Mount	right-hand rotation	left-hand rotation	right-hand and left-hand rotation	With draw-off nut.	Weight approx. g
1341583	MT3	•				5600
1341584	MT3	•			•	5600
1341585	MT3		•			5900
1341586	MT3		•		•	5900
1381617	MT3			•		5600
1382287	MT3			•	•	5900
1341587	MT4	•				6000
1341588	MT4	•			•	6000
1341589	MT4		•			6300
1341590	MT4		•		•	6300
1381618	MT4			•		6000
1382288	MT4			•	•	6300
1341591	MT5	•				6600
1341592	MT5	•			•	6600
1341593	MT5		•			6900
1341594	MT5		•		•	6900
1381619	MT5			•		6600
1382289	MT5			•	•	6900
1341595	MT6	•				8300
1341596	MT6	•			•	8300
1341597	MT6		•			8500
1341598	MT6		•		•	8500
1381620	MT6			•		8300
1382290	MT6			•	•	8500
1341599	ZA25	•				5600
1341600	ZA25		•			5600
1381615	ZA25			•		5600
1341601	ZA32	•				6000
1341602	ZA32		•			6000
1381616	ZA32			•		6000



# Notes

# CoK-AE - power-operated

Constant face driver  
CoK-AE

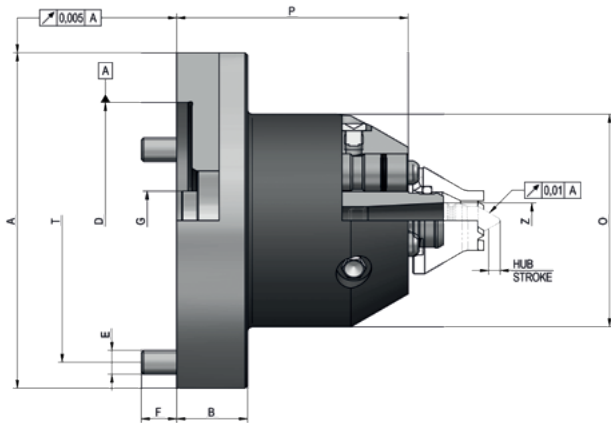

### APPLICATION

For machining workpieces with high unbalance, heavy weight, high chip removal or irregular cutting. Can be used in clockwise and counterclockwise rotation. Radially backlash-free.

### TYPE

Force-actuated face driver with mechanical pressure compensation. Clamping circuit Ø 8-80 mm. Max. workpiece weight 350 kg.

### CUSTOMER BENEFITS

- ⊕ Maximum concentricity deviation of 0.01 mm for maximum precision
- ⊕ Workpiece longitudinal stop realized in centering
- ⊕ Low centering force, even at max. cutting load
- ⊕ Maximum flexibility thanks to universal exchange of driving disc and centre point

### TECHNICAL FEATURES

- The drivers are pressed against the workpiece with force-actuation

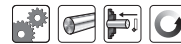

C15  
Basic body (without centre, without draw-off nut), mechanical

Item no.	A mm	B mm	D mm	E	F mm	G mm	O mm	P mm	T mm	Z mm	Centres stroke mm	Weight approx. g
1340444	142	30	100	M10	15	25	90	93	120	15	5	6500

# Adapter plate CoK-AE

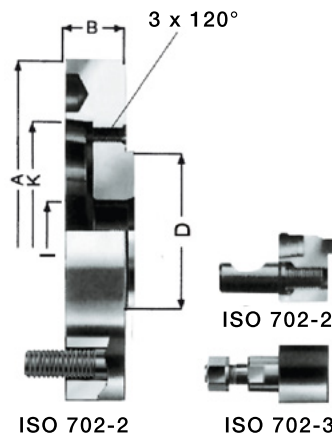

A14  
Adapter plate short taper

Item no.	Design	Taper	A mm	B mm	D mm	I mm	K mm	Weight approx. g
088485	ISO 702-1	5	140	30	100	38	82,563	3100
088486	ISO 702-1	6	167	35	100	38	106,39	4800
088487	ISO 702-1	8	216	40	100	38	139,735	8700
088488	ISO 702-1	11	280	45	100	38	196,885	17000
088480	ISO 702-3	5	140	30	100	38	82,563	3100
088481	ISO 702-3	6	167	35	100	38	106,39	4800
088482	ISO 702-3	8	216	40	100	38	139,735	8700
088483	ISO 702-3	11	280	45	100	38	196,885	17000
088495	ISO 702-2	5	140	30	100	38	82,563	3100
088496	ISO 702-2	6	167	35	100	38	106,39	4800
088497	ISO 702-2	8	216	40	100	38	139,735	8700
088498	ISO 702-2	11	280	45	100	38	196,885	17000

# Accessories CoK-AE

A14

**Driving discs, with interchangeable carbide driving plates 6 x 3.2, right- and left-hand rotation, max. workpiece hardness 40 HRC**

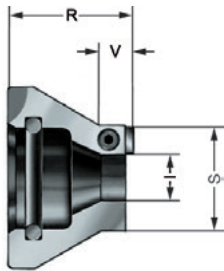

Item no.	Clamping circuit Ø S mm	Approx. turning range	l mm	R mm	V mm	Assoc. centre point Ø Y mm	Axial load max. N
1341624	20 H	21-40	7	30	5	6	8000
1341625	25 H	26-50	11	30	8	10	8000
1341626	32 H	33-64	17,5	30	10	16	8000

A14

**Driving discs, with interchangeable carbide driving plates 6 x 3.2, right-hand rotation, max. workpiece hardness 40 HRC**

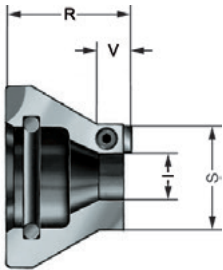

Item no.	Clamping circuit Ø S mm	Approx. turning range	l mm	R mm	V mm	Assoc. centre point Ø Y mm	Axial load max. N
1341628	20 H	21-40	7	30	5	6	8000
1341629	25 H	26-50	11	30	8	10	8000
1341630	32 H	33-64	17,5	30	10	16	8000

A14

**Driving discs, with interchangeable carbide driving plates 6 x 3.2, left-hand rotation, max. workpiece hardness 40 HRC**

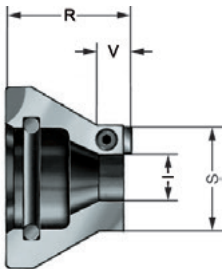

Item no.	Clamping circuit Ø S mm	Approx. turning range	l mm	R mm	V mm	Assoc. centre point Ø Y mm	Axial load max. N
1341631	20 H	21-40	7	30	5	6	8000
1341632	25 H	26-50	11	30	8	10	8000
1341633	32 H	33-64	17,5	30	10	16	8000

A14

**Driving discs, toothed, right- and left-hand rotation, max. workpiece hardness 35 HRC**

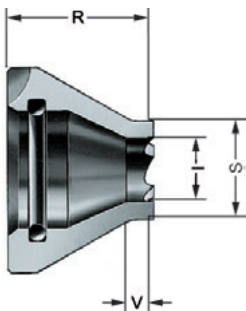

Item no.	Clamping circuit Ø S mm	Approx. turning range	l mm	R mm	V mm	Assoc. centre point Ø Y mm	Axial load max. N
1341603	8	9-16	4,5	38	4	4	4000
1341604	10	11-20	4,5	38	4	4	6000
1341605	12	13-24	7	36	4	6	6000
1341606	16	17-32	11	33	4	10	6000
1341607	20	21-40	13	30	4	12	8000
1341608	25	26-50	17	30	8	16	10000
1341609	32	33-64	22	30	10	16	12500

Driving discs with carbide tothing on request

# Accessories CoK-AE

A14

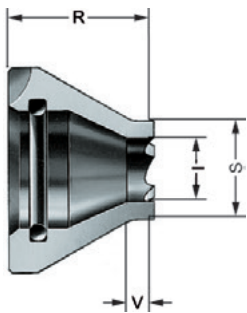
**Driving discs, toothed, right-hand rotation, max. workpiece hardness 35 HRC**

Item no.	Clamping circuit $\varnothing$ S mm	Approx. turning range	l mm	R mm	V mm	Assoc. centre point $\varnothing$ Y mm	Axial load max. N
1341610	8	9-16	4,5	38	4	4	4000
1341611	10	11-20	4,5	38	4	4	6000
1341612	12	13-24	7	36	4	6	6000
1341613	16	17-32	11	33	4	10	6000
1341614	20	21-40	13	30	4	12	8000
1341615	25	26-50	17	30	8	16	10000
1341616	32	33-64	22	30	10	16	12500

Driving discs with carbide toothing, friction lining or diamond grain on request

A14

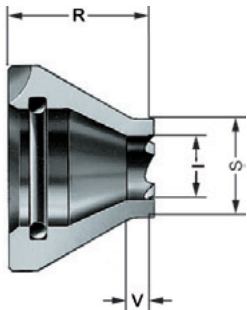
**Driving discs, toothed, left-hand rotation, max. workpiece hardness 35 HRC**

Item no.	Clamping circuit $\varnothing$ S mm	Approx. turning range	l mm	R mm	V mm	Assoc. centre point $\varnothing$ Y mm	Axial load max. N
1341617	8	9-16	4,5	38	4	4	4000
1341618	10	11-20	4,5	38	4	4	6000
1341619	12	13-24	7	36	4	6	6000
1341620	16	17-32	11	33	4	10	6000
1341621	20	21-40	13	30	4	12	8000
1341622	25	26-50	17	30	8	16	10000
1341623	32	33-64	22	30	10	16	12500

Driving discs with carbide toothing, friction lining or diamond grain on request

A14

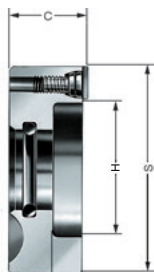
**Driving discs, with interchangeable carbide driving plates 9.5 x 3.2, right- and left-hand rotation, max. workpiece hardness 40 HRC**

Item no.	Clamping circuit $\varnothing$ S mm	Approx. turning range	H mm	C mm	Assoc. centre point $\varnothing$ Y mm	Axial load max. N
1341627	40	41-80	20	24	16	14000
1341635	50	51-100	28	24	16	14000
1341636	63	64-126	41	24	16	14000
1341637	80	81-160	58	24	16	14000

A14

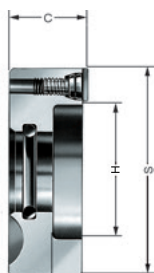
**Driving discs, with interchangeable carbide driving plates 9.5 x 3.2, right-hand rotation, max. workpiece hardness 40 HRC**

Item no.	Clamping circuit $\varnothing$ S mm	Approx. turning range	H mm	C mm	Assoc. centre point $\varnothing$ Y mm	Axial load max. N
1341638	40	41-80	20	24	16	14000
1341639	50	51-100	28	24	16	14000
1341640	63	64-126	41	24	16	14000
1341641	80	81-160	58	24	16	14000

# Accessories CoK-AE

A14

**Driving discs, with interchangeable carbide driving plates 9.5 x 3.2, left-hand rotation, max. workpiece hardness 40 HRC**

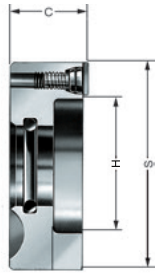

Item no.	Clamping circuit Ø S mm	Approx. turning range	H mm	C mm	Assoc. centre point Ø Y mm	Axial load max. N
1341642	40	41-80	20	24	16	14000
1341643	50	51-100	28	24	16	14000
1341644	63	64-126	41	24	16	14000
1341645	80	81-160	58	24	16	14000

Accessories Constant face driver CoK-AE

C15

**Centres, CoK-AE**

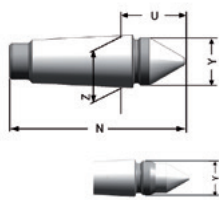

Item no.	Clamping circuit Ø S mm	N mm	U mm	Y mm	Z mm	Workpiece weight max. kg
088121	8-10	67,5	28	4	15	55
088122	12	67	28	6	15	75
088123	16	67	28	10	15	150
088124	20-32	64	25	12	15	250
085002	40-80	60	21	M 14x1,5	15	350

A14

**Carbide driving plates, right- or left-hand rotation**



Item no.	Size	Clamping circuit Ø mm
088209	9,5x3,2	40-80

A14

**Carbide driving plates, right- and left-hand rotation**

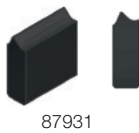

Item no.	Size	Clamping circuit Ø mm
087931	9,5x3,2	40-80

C15

**Clamping spindle**



Item no.	Size	Clamping circuit Ø mm
088205	M 5 x 8	40-80

C15

**O-Ring**



Item no.	Size
006252	21,82x3,53

# Special solutions

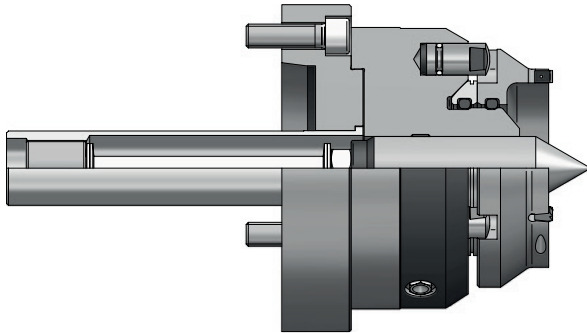

## CoM - mechanical pressure compensation with driving disc

### APPLICATION

For clamping large and heavy workpieces, as well as workpieces with extremely uneven faces.

### TYPE

Basic body and adapter plate with disc spring package and morse taper or short taper.

### CUSTOMER BENEFITS

- ⌚ Resilient, stable centre point, axially adjustable
- ⌚ Workpiece weight up to 500 kg
- ⌚ Clamping circuit diameter 50-250 mm
- ⌚ Interchangeable driving disc

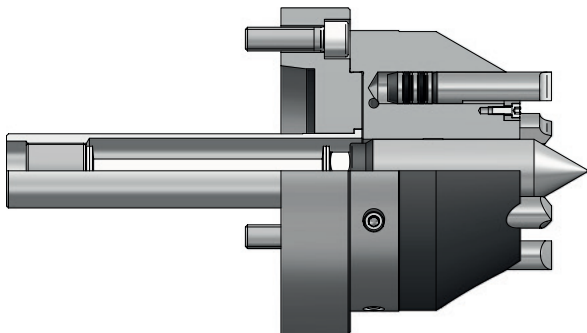

## CoB - hydraulic pressure compensation with driving pin

### APPLICATION

For clamping large and heavy workpieces, as well as workpieces with extremely uneven faces.

### TYPE

Basic body with morse taper or short taper. Adapter plate with disc spring package.

### CUSTOMER BENEFITS

- ⌚ Resilient, stable centre point, axially adjustable
- ⌚ Workpiece weight up to 500 kg / 1000 kg
- ⌚ Clamping circuit diameter 63-160 mm





# Notes

# The headquarters: our main plant in Sontheim/Brenz

The RÖHM main plant is located in Sontheim/Brenz. In this ultra-modern production facility comprising 41,000 m<sup>2</sup> optimum conditions have been achieved in order to solve the extensive range of discerning construction and production tasks making the company even better, faster and more efficient in the future.



Sontheim/Brenz

**Sontheim** | All national and international activities are planned and coordinated at the administrative headquarters in Sontheim. Thanks to the excellent infrastructure and transport routes, this location is ideal for a company relying on perfect product quality as well as maximum flexibility. Furthermore, the region around Sontheim offers another key basis for the success of our company: it is rich in quality awareness and motivated employees with the result that we are ideally prepared for the challenges of the future. The main plant uniquely unites mass production, serial production and customised individual production under a single roof.

# Key locations for the company: Dillingen and St. Georgen

Such strong growth on the part of the RÖHM Group is also obviously associated with higher requirements on development and production capacities. The demands of today and tomorrow can be complied with the two facilities in Dillingen and St. Georgen.



Dillingen/Danube



St. Georgen

**Plant Dillingen/Danube** | This branch plant in Dillingen was put into operation by the RÖHM Group as early as 1953. Thanks to extremely positive development, the plant is subject to constant expansion and modernisation. For this reason, new modern production facilities were built in 1982 and 1991. In 2007 RÖHM built a new production hall for two portal turning and milling machines. This enables machining of workpieces up to 4 metres in length which will secure a leading market position for RÖHM in the future. More than 300 employees are primarily involved in engineering and manufacturing lathechucks, machine vices and special clamping equipment for turning and milling machinery as well as for machining centres.

**Engineering and sales department St. Georgen** | Apart from standard mandrels, tailor-made solutions for a wide variety of requirements are also manufactured here in this small but accomplished high-tech forge. RÖHM retains mechanical or power-operated mandrels, sliding jaw mandrels and hydraulic mandrels for its customers for tensioning workpieces in drill holes or interior contours.

# Always close to our customers. With locations all around the world.



Customer orientation at RÖHM has less to do with marketing than with attitude. We consider customer proximity as an intensive dialogue with our partners as well as direct presence on key international markets.



# Your contacts at RÖHM

## Manufacturing and distribution bases

### Germany:

RÖHM GmbH  
Heinrich-Röhm-Straße 50  
89567 Sontheim/Brenz  
Tel 0049 73 25 – 16 0  
Fax 0049 73 25 – 16 510  
sales@roehm.biz  
www.roehm.biz

### RÖHM GmbH

Röhmstraße 6  
89407 Dillingen  
Tel 0049 90 71 – 5 08-0  
Fax 0049 90 71 – 5 08-174  
sales@roehm.biz  
www.roehm.biz

### RÖHM GmbH

Feldbergstr. 5  
78112 St. Georgen  
Tel 0049 – 77 24 – 94 68 12  
Fax 0049 – 77 24 – 51 89  
sales@roehm.biz  
www.roehm.biz

### China:

ROEHM China Co., Ltd.  
Room 702, Building 24,  
No. 518 Xinzhuan Road,  
Songjiang District,  
201612 Shanghai  
Tel 0086 – 21 – 37 70 53 95  
roehmcn@roehm.biz  
www.roehm.biz/zh

### France:

RÖHM S.A. R. L.  
325 rue Paul Langevin  
BP 90204  
F-60744 Saint Maximin cedex  
Tel 0033 – 344 64 10 00  
Fax 0033 – 344 64 00 68  
fr.commercial@roehm.biz  
www.roehm.biz/fr

### Great Britain:

ROHM (Great Britain) LTD.  
27 Webb Ellis Business Park,  
Woodside Park, Rugby,  
CV21 2NP  
Tel +44 1788 228 469  
rohmgb@roehm.biz  
www.roehm.biz/en

### Hungary:

RÖHM Hungaria Kft.  
Gyár u. 2. (BITEP Ipari Park)  
H-2040 Budaörs  
Tel 0036 – 209 – 324 597  
roehmhungary@roehm.biz  
www.roehm.biz

### Italy:

RÖHM Italia SRL  
Via Reiss Romoli 17/19  
20019 Settimo Milanese (MI)  
Palazzo Rothenberger  
Tel 0039 – 02 – 92 10 35 31  
rohmitalia@roehm.biz  
it.roehm.biz  
www.roehm.biz/it

### Mexico:

RÖHM Products México S. de R.L.  
Emilio Garza Meléndez #6606  
Col. Campestre Mederos  
Monterrey, N.L., México, C.P. 64970  
Tel 0052 81 – 9627 – 0686  
info@roh-products.com  
www.roehm.biz/es

### Poland:

ROEHM Polska Sp. z o.o.  
ul. Sienna 73  
00-833 Warszawa / Polska  
Tel.: +48 605 665 663  
roehmpolska@roehm.biz  
www.roehm.biz

### Spain:

RÖHM Iberica S.A.  
C/Rejas, No. 9 Nave 11 D  
28022 Madrid  
Tel 0034 – 91 – 3 13 57 90  
Fax 0034 – 91 – 3 13 57 93  
rohiberica@roehm.biz  
www.rohmiberica.com  
www.roehm.biz/es

### Switzerland:

RÖHM Spanntechnik AG  
Feldstraße 39, 3360 Herzogenbuchsee  
Tel 0041 – 629 56 30 20  
Fax 0041 – 629 56 30 29  
roehm.ch@roehm.biz  
www.roehm.biz

### USA:

Roehm Products of America Inc.  
2500 Northlake Drive,  
Suwanee GA 30024  
Tel +1-770-963-8440  
Fax +1-770-963-8407  
sales@roh-products.com  
www.rohm-products.com

Presence on all continents from A for Australia to V for Vietnam. You can receive the contact information of our worldwide representations easily through **www.roehm.biz**.

## Sales Agents in Germany

### Baden-Wuerttemberg:

Thomas Haas  
Mobil 0152 / 22 88 71 20  
thomas.haas@roehm.biz

Richard Sedlak  
Mobil 0152 / 22 88 70 30  
richard.sedlak@roehm.biz

Dirk Gaarz  
Mobil 0152 / 22 88 71 16  
dirk.gaarz@roehm.biz

### Baden-Wuerttemberg / Rhineland-Palatinate / Saarland:

Michael Schmitz  
Mobil 0152 / 22 88 70 18  
michael.schmitz@roehm.biz

### Bavaria North:

Steffen Blatz  
Mobil 0152 / 22 88 70 16  
steffen.blatz@roehm.biz

### Bavaria South-West:

Gerhard Häutle  
Mobil 0152 / 22 88 70 15  
gerhard.haetule@roehm.biz

### Bavaria South-East:

Adolf Hausler  
Mobil 0152 / 22 88 70 26  
adolf.hausler@roehm.biz

### North Rhine-Westphalia

Ralf Schnichels  
Mobil 0152 / 22 88 70 25  
ralf.schnichels@roehm.biz

### Schleswig-Holstein, Hamburg, Bremen:

Friedhelm Schneider  
Mobil 0152 / 22 88 70 17  
friedhelm.schneider@roehm.biz

### North Rhine-Westphalia / Lower Saxony

Thorsten Nolte  
Mobil 0152 / 22 88 70 31  
thorsten.nolte@roehm.biz

### Berlin, Mecklenburg-Western Pomerania, Brandenburg, Saxony, Saxony-Anhalt,

Thuringia:  
Matthias Barth  
Mobil 0152 / 22 88 71 46  
matthias.barth@roehm.biz

### Hesse:

Klaus Dieter Hofmann  
Mobil 0152 / 22 88 70 29  
k.d.hofmann@roehm.biz

## Agents worldwide

### Algeria:

RÖHM S.A.R.L.  
325 rue Paul Langevin  
BP 90204  
F-60744 Saint Maximin cedex  
Frankreich  
Tel 0033 – 344 64 10 00  
Fax 0033 – 344 64 00 68  
fr.commercial@roehm.biz  
www.roehm.biz/fr

### Australia:

SECUREFIX  
101 BRADMAN STREET  
4110 ACACIA RIDGE QLD  
Tel 61730633230  
sales@securefix.com.au

### Austria:

Martin Kremser  
Untergreith 158  
8443 Gleinstätten  
Tel 00 43 / 66 49 23 77 10  
martin.kremser@roehm.biz

### Schachermayer GmbH

Schachermayer Str. 2  
Postfach 3000, 4021 Linz  
Tel 00 43 / 732 / 65 99-0  
Fax 00 43 / 732 / 65 99 14 44  
maschinenmetall@schachermayer.at

### Lackner u. Urnitsch GmbH

Bahnhofgürtel 37, 8020 Graz  
Tel 00 43 / 316 / 71 14 80-0  
Fax 00 43 / 316 / 71 14 80 39  
lackner@urnitsch.at

### Metzler GmbH u. Co. KG

Oberer Paspelsweg 6-8, 6830 Rankweil  
Tel. 00 43 / 55 22 / 7 79 63 - 0  
Fax 00 43 / 55 22 / 7 79 63 - 6  
office@metzler.at

### Belgium:

RÖHM S.A.R.L.  
325 rue Paul Langevin  
BP 90204  
F-60744 Saint Maximin cedex  
Frankreich  
Tel 0033 – 344 64 10 00  
Fax 0033 – 344 64 00 68  
fr.commercial@roehm.biz  
www.roehm.biz/fr

### BELTRACY

Bergensesteenweg 189  
1600 Sint-Pieters-Leeuw  
BELGIEN  
Tel 00 32 / 25 43 68 90  
Fax 00 32 / 25 38 59 10  
info@beltracy.be  
www.beltracy.be

### Brazil:

O.V.D. Importadora e Distribuidora Ltda.  
Rua João Betttega, 2876 – Portão –  
CEP: 81.070-900  
Curitiba, PR, Brazil  
76.635.689/0001-92  
(+41) 2101 2500

### Canada:

Roehm Products of America Inc.  
2500 Northlake Drive,  
Suwanee GA 30024  
Tel +1-770-963-8440  
Fax +1-770-963-8407  
sales@rohm-products.com  
www.rohm-products.com

### Croatia:

PFEIFER - TTI D.O.O.  
Spinciceva 2 a  
40000 Cakovec, Kroatien  
Tel 00 385-40391-123  
Fax 00 385-40391-123  
pfeifer-tti@pfeifer-tti.hr  
www.pfeifer-tti.hr

### Czech Republic:

RÖHM GmbH  
Heinrich-Röhm-Straße 50  
89567 Sontheim/Brenz  
Tel 00421 914 122 932  
peter.trnka@roehm.biz  
www.roehm.biz

### Denmark:

O. Ryttergaard Værktøj A/S  
Falkevej 13  
3400 Hillerød  
Tel 00 45 36 70 65 55  
info@ryttergaard.com  
www.ryttergaard.com

### Finland:

Teräskonttori Oy,  
Muuntotie 3  
1510 Vantaa  
Tel 00 358 / 9615471  
Fax 00 358 / 9674954  
info@teraskonttori.fi  
www.teraskonttori.fi

### Oy Interfil Ltd.

Vähäheikkiläntie 56B, 2nd floor  
20810 Turku  
Tel 00 358 / 2 01 47 45 00  
Fax 00 358 / 2 01 47 45 01  
info@p-aro.com  
www.interfil.com

### Greece:

K.S.PAPADOPOULOS & CO.  
ETHNIKIS ANTISTASEOS 7A,  
55134 Thessaloniki  
Tel 00 30 / 23 10-48 87 58  
Fax 00 30 / 23 10-48 87 53  
stefanos@agent.com.gr

### Iceland:

Fossberg Ltd.  
Dugguvogi 6, 104 Reykjavik  
Tel. 00 354 / 57 57 600  
fossberg@fossberg.is  
www.fossberg.is

### India:

R.H POWER UTILITIES PVT.LTD  
KIADB 2ND PHASE  
572106 TUMKUR KARNATAKA  
Tel 0091 816 2970276  
rhp.tmk@rajamane.com

### OMKAR SUPRANATIONAL PVT LTD

SAHAKARNAGAR  
411009 PUNE MAHARASHTRA  
Tel 0091/2024223054  
info@omkarsupra.com

### Ireland:

ROHM (Great Britain) LTD.  
27 Webb Ellis Business Park,  
Woodside Park, Rugby,  
CV21 2NP  
Tel +44 1788 228 469  
rohmb@roehm.biz  
www.roehm.biz/en

### Israel:

ETMOS ETM TOOLING LTD.  
34 HAHOFER ST., 5885807 Holon  
Tel. 00 972 - 3 / 55 81 933  
Fax 00 972 - 3 / 55 81 934  
etmos@etmos.co.il  
www.etmos.co.il

### Japan:

Takeda Trade Co., Ltd.  
NAKANOSHIMA DAI-BUILDING 603, 3-3-23,  
NAKANOSHIMA, KITA-KU  
530-6106 OSAKA  
Tel. 00 81 06-6441-1503  
mail@takeda-trade.co.jp  
www.takeda-trade.co.jp

### Kazakhstan:

«Spanntech» LLP  
Astana, st. Valikhhanov 19, room 69  
010000, Republic of Kazakhstan,  
support@spanntech.kz

### Letvia:

SIA „INSTRO”  
LACPLESA STR. 87  
1011 Riga  
Tel 371/67288546  
instrumentu.nodala@instro.lv

### Luxembourg:

RÖHM S.A.R.L.  
325 rue Paul Langevin  
BP 90204  
F-60744 Saint Maximin cedex  
Frankreich  
Tel 0033 – 344 64 10 00  
Fax 0033 – 344 64 00 68  
fr.commercial@roehm.biz  
www.roehm.biz/fr

### Macedonia:

DEMEX DOO  
GROBLJANSKA NO.3, OSTRUZNICA  
11251 Belgrade  
Tel 00 381 / 1 1 26 52 999  
Fax 00 381 / 1 1 26 52 562  
office@demaxbg.com

### Malaysia:

KS PRECISION TOOLS (M) SDN BHD  
TAMAN SERDANG RAYA, SECTION 9  
43300 SERI KAMBANGAN, SELANGO D.E.  
Tel 60389417168  
sales@ks-precision.com  
www.ks-precision.com

### Morocco:

RÖHM S.A.R.L.  
325 rue Paul Langevin  
BP 90204  
F-60744 Saint Maximin cedex  
Frankreich  
Tel 0033 – 344 64 10 00  
Fax 0033 – 344 64 00 68  
fr.commercial@roehm.biz  
www.roehm.biz/fr

### Netherlands:

RÖHM S.A.R.L.  
325 rue Paul Langevin  
BP 90204  
F-60744 Saint Maximin cedex  
Frankreich  
Tel 0033 – 344 64 10 00  
Fax 0033 – 344 64 00 68  
fr.commercial@roehm.biz  
www.roehm.biz/fr

### Boorwerk B.V.,

VELUWEZOOM 50  
1327 AH, ALMERE  
Tel 00 31 36 521 8080  
Fax 00 31 36 521 4200  
verkoop@boorwerk.nl  
www.boorwerk.nl



## Agents worldwide

### Norway:

Ing. Yngve Ege A/S  
Ryenstubbën 5  
0679 Oslo 11  
Tel 00 47 / 23 24 10 00  
Fax 00 47 / 23 24 1001  
ege@ege.no  
www.ege.no

### KASPO MASKIN AS

Postboks 6282 Sluppen  
7489 Trondheim  
Tel 00 47 / 73 96 96 00  
Fax 00 47 / 73 96 96 01  
kaspo@kaspo.no

### Portugal:

#### RÖHM Iberica S.A.

C/Rejas, No. 9 Nave 11 D  
28022 Madrid  
Tel 0034 – 91 – 3 13 57 90  
Fax 0034 – 91 – 3 13 57 93  
rohiberica@roehm.biz  
www.rohiberica.com  
www.roehm.biz/es

Paulo Fernandes  
Tel 00351 926853881

### Romania:

KSN Technik Srl  
Str. Tabacarilor 15B/103  
400139 CLUJ-NAPOCA, Rumänien  
Tel 00 40 / 264 / 449 - 533  
Fax 00 40 / 264 / 449 - 533  
office@ksntechnik.ro  
www.ksntechnik.ro

### Singapore:

GP System Singapur PTE LTD  
No. 51, Bukit Batok Crescent,  
#04-04/05 Unity Centre,  
Singapore 658077  
Tel. 00 65 / 68 61 - 26 63  
Fax 00 65 / 68 61 - 35 00  
enquiry@gpsystem.com  
www.gpsystem.com

### Slovakia:

RÖHM GmbH  
Heinrich-Röhm-Straße 50  
89567 Sontheim/Brenz  
Tel 00421 914 122 932  
peter.trnka@roehm.biz  
www.roehm.biz

### Slovenia:

B T S COMPANY TRGOVINA  
Bratislavka 5  
1000 Ljubljana  
Tel 00 38 / 6 1 584 14 40  
info@bts-company.si  
www.bts-company.com

### South Korea:

CHEONG-DO MACHINE TOOLS CO., LTD.  
GURO-GO(GURO-DONG)  
8212 Seoul  
cdmt@chol.com

### KMC CO.

DONGTANCHEOMDANSANEOP 1-RO  
18469 HWASEONG-SI,GYEONGGI-DO  
chelee@naver.com

### Sweden:

Techpoint Systemteknik AB  
Box 717  
19127 Sollentuna  
Tel 00 46 / 86 23 13 30  
Fax 00 46 / 86 23 13 45  
info@techpoint.se  
www.techpoint.se

### CHUCKTEKNIK NORDEN AB

Finjaryd 2519  
28291 Tyringe  
Tel 00 46 / 40 12 33 44  
info@chuckteknik.com  
www.chuckteknik.com

### Thailand:

KRASSTEC CO., LTD.  
SUAN LUANG  
10250 BANGKOK  
Tel. 006602 732-1144  
krasscom@krasstec.com

### Tunisia:

RÖHM S.A.R.L.  
325 rue Paul Langevin  
BP 90204  
F-60744 Saint Maximin cedex  
Frankreich  
Tel 0033 – 344 64 10 00  
Fax 0033 – 344 64 00 68  
fr.commercial@roehm.biz  
www.roehm.biz/fr

### Turkey:

Sintek Mühendislik Makina San.  
Tarabya Mahallesi  
Yumak Sok. No: 3/A1  
34457 SARIYER – İSTANBUL  
Tel. 00 90 / 212 / 2 99 61 84  
Fax 00 90 / 212 / 2 99 66 75  
info@sintekmuhendislik.com

### Vietnam:

CAP DO INDUSTRIAL EQUIPMENT CO.LTD.  
TAN BINH DIST.  
70000 HO-CHI-MINH-CITY  
Tel 84838104533  
Fax 84838108427  
Office01@capdo.com.vn  
www.capdo.com.vn/

# General Terms of Sale and Delivery

## § 1 Offer, conclusion of contract and contractual contents

1. Our Terms of Sale shall apply exclusively; we do not recognise contradictory terms and conditions or terms and conditions which deviate from our Terms of Sale unless we have explicitly approved their validity in writing. Our Terms of Sale shall also apply if we carry out the delivery to the buyer without reservation in the knowledge of contradictory terms and conditions of the buyer or terms and conditions which deviate from our Terms of Sale.
  2. Our Terms of Sale shall only apply towards an entrepreneur within the meaning of Section 14 BGB [German Civil Code].
  3. Our General Service Terms shall apply with precedence over these Terms of Sale in the respective valid version in cases, which comprise the service offer of RÖHM GmbH.
  4. Our offers are always to be understood as invitatio ad offerendum and are therefore without obligation insofar as they have not explicitly been described as binding. The contract shall only be concluded with our written confirmation and in line with its contents and – if a written confirmation is missing – by the service/delivery. If a delivery/service is carried out immediately without a confirmation then the invoice shall at the same time be deemed as an order confirmation.
  5. Costs for the production of drawings for special constructions are to be borne by the orderer insofar as the offer does not lead to an order for reasons, for which we are not responsible.
  6. All details concerning weights, dimensions, services and technical data, which are contained in our printed material, catalogues, price lists or in other contractual documents, merely serve for purposes of information and are only binding insofar as they are explicitly described as binding.
  7. We reserve the right to make construction and form changes to the object of contract insofar as no changes are made hereto, which are deemed unreasonable for the orderer.
  8. The documentation consists of the compilation drawing, the BOM with marking of the parts subject to wear and tear and spare parts as well as assembly instructions upon request. Respectively in German and/or, upon request, in English. This free documentation will be supplied in a digital form. The PDF format shall apply to drawings, BOMs and texts. Any scope of documentation beyond this is liable to costs respectively requires a special agreement. The documents may not be reproduced in full or in part, not made accessible to third parties or used for any other purpose apart from that for which they were handed over to the customer without our prior written authorization.
  9. The corresponding measurement methods for tests, with which certain temperatures, times and other measured or control values should apply, must be stipulated before start of delivery and recognised by both parties. If no stipulation is made the measurement methods usually applied by RÖHM shall apply, we shall provide the details thereof upon request.
  10. Samples will only be supplied against payment and owing to a separately placed order.
  11. Assurances, collateral agreements and amendments to the contract require a written form in order to be valid. This requirement cannot be waived orally.
  12. Placed orders are irrevocable unless the supplier has approved the revocation in writing.
  13. In case of export business the delivery is carried out at the conditions agreed on the order confirmation, the international regulations for the interpretation of customary contractual forms shall apply in addition (incoterms 2010 of the International Chamber of Commerce, respective valid status).
  14. Our General Business Terms shall apply to the RÖHM online shop with the following supplementations:
    - a) The offer on the part of the customer is submitted binding as soon as the customer orders the products in the shopping basket by using the function „binding order“.
    - b) A purchase in the online shop is only possible if the customer actively agrees to our General Business Terms.
    - c) Mistakes and errors with regard to the goods availability, prices and other details and data excepted. Diagrams in the online shop are merely for the purpose of illustration respectively as visual aids; the description is binding.
    - d) We will inform the customer if the product ordered by the customer is temporarily or permanently not available.
  15. Our „product information“, technical information leaflets as well as other product-specific publications shall apply in addition to the General Business Terms. These are always to be compiled with in their current version.
  16. Upon conclusion of a contract between Röhms and the buyer both parties undertake to observe and comply with the applicable laws and regulations as well as the current RÖHM Code of Conduct. The Code of Conduct can be found at [www.roehm.biz/Code of Conduct for Business Partners](http://www.roehm.biz/Code of Conduct for Business Partners)
- ## § 2 Prices
1. In the absence of special written agreements the prices in the Federal Republic of Germany shall apply „carriage paid“ recipient plus the statutory value added tax. With export business the object of delivery shall be deemed as sold „ex works“ if nothing is determined in the contract concerning the type of sale. A processing fee of EUR 15.00 will be charged for individual orders with a goods value of less than EUR 150.00 net, a processing fee of EUR 30.00 for orders with a goods value of less than EUR 50.00 net respectively plus the applicable rate of value added tax. This shall apply to deliveries within the domestic country and overseas. At the customer's request the goods can be delivered to an alternative shipping address against a logistics fee in the amount of EUR 10.00.
  2. We would like to point out that we will only carry out the shipment at the customer's request. This shall have no effect on the regulations according to Section 5.
  3. We shall charge the prices valid upon conclusion of the contract, which are based on the cost factors which are valid at this time. Should these cost factors (in particular material, wages, energy, etc.) change between conclusion of the contract and the agreed delivery time then we are entitled to make a corresponding change to the prices. In case of export business the supplier is entitled to terminate the contract extraordinarily with regard to the part of the order that has not yet been completed or to adjust the prices for this accordingly in the event of a substantial devaluation in the currency, in which the order is concluded.
  4. In case of conclusion ex works the goods will be conveyed at the costs and risk of the orderer. With all other consignments the provisions stipulated in the incoterms 2010, respective valid status, will apply with regard to insurance and the assumption of risks.
  5. We will inform the buyer of our production quantity for parts/products, which are produced especially according to the buyer's requests. The buyer undertakes to purchase

the quantities confirmed to him.

6. Excess and shortfalls in deliveries of up to 5 %, with special tools up to 10 %, at least however 2 pieces, are permitted and do not substantiate any quality defects. The respective delivery will be charged.

## § 3 Terms of payment

1. In the absence of a special agreement the payment is to be made without any deduction free paying agent within 10 days after the invoice date – also with partial deliveries.
2. In case of default of payment interest will be charged in the amount of the credit costs charged by banks, at least however interest in the amount of 9 % above the respective base lending rate of the ECB.
3. In case of export business the payments are to be made in line with the agreed terms of payment.
4. Costs of the payment transactions, in particular bank charges for overseas transfers to us, shall principally be for the expense of the customer.

## § 4 Delivery time

1. The start of the delivery deadline stated by us presumes the clarification of all technical questions. Delivery dates stated by us are – insofar as not explicitly agreed or described as binding – non-binding and shall merely represent an expected delivery date.
2. The compliance with our delivery obligation further presumes the timely and proper fulfillment of the buyer's obligations, in particular the compliance with the agreed terms of payment. The right is reserved to the plea of the unfulfilled contract. This right shall also consist of obligations from previous deliveries which have not been satisfied in full.
3. The delivery deadline shall begin with the sending of the order confirmation, however not before the provision of the documents, permit, releases, etc., which are to be procured by the orderer, as well as not before the receipt of the agreed down payment.
4. If a binding delivery date has been agreed then the supplier also has to deliver within the deadline. The delivery deadline shall have been adhered to if the object of delivery has left the plant by the time it expires or notification has been given that the object is ready for delivery, the right is reserved to the timely and correct self-delivery. If the orderer changes his order with regard to parts of the delivery then the delivery deadline shall only begin to apply new again with the confirmation of the change.
5. Force majeure, war, civil commotion, strike, lock-out or measures of authorities, no matter for what reason, which oppose a delivery, as well as deficiencies of raw materials, of transport means as well as theft – also at the sub-suppliers – shall release the supplier from the obligation to deliver within the agreed deadline. The orderer is to be notified immediately of the occurrence of the event and of the expected implications.
6. Deliveries before expiry of the delivery time and in reasonable parts are permitted.
7. The adherence to the delivery time presumes the fulfillment of the orderer's contractual obligations.
8. The regulations of Subclause 10 shall apply in the event of the delay in delivery or impossibility.

## § 5 Passing of risk and acceptance

1. The risk shall pass to the orderer by no later than with the despatch of the delivered parts also if partial deliveries are made or we have taken over other services e.g. the shipping costs or delivery to the location and installation.
2. At the orderer's request the shipment shall be insured by us against theft, damages caused by breakage, transport, fire and water and other insurable risks at his costs.
3. If the shipment is delayed as a result of circumstances, for which the orderer is responsible, then the risk shall pass to the orderer from the day upon which the goods are ready for shipment; however we are obliged to procure the insurances, which he requests, at the request and costs of the orderer.
4. Delivered objects are, even if they feature insignificant features, to be accepted by the orderer irrespective of the rights from Section 8.

## § 6 Delay in acceptance, order on call

1. If the orderer does not accept the object of contract within the deadline we are entitled to set him a reasonable final deadline, to dispose otherwise over the object after its expiry and to supply the orderer with a reasonably extended deadline. Our rights to cancel the contract under the pre-requisites of Section 326 BGB and to request damages owing to the non-fulfilment shall remain unaffected hereby. If we request damages owing to non-fulfilment we can request 40 % of the agreed price plus value added tax as compensation unless the orderer proves less damages. We reserve the right to assert higher actual damages.
2. Orders, which are confirmed by us on call, must – insofar as nothing special has been agreed – be accepted by no later than within one year from the order date. The same shall apply in case of date reservations or sustainable „on call position“. Subclause 6.1 shall apply accordingly in case the goods are not called within the stated deadline.

## § 7 Reservation of title

1. The objects of the deliveries (reserved goods) shall remain our property until the fulfillment of all claims to which we are entitled against the buyer from the business relationship. Insofar as the value of all security rights, to which we are entitled against the buyer, exceed the amount of all secured claims by more than 10 %, we will release a corresponding part of the security rights at the buyer's request.
2. During the existence of the reservation of title the buyer is prohibited from a pledge or assignment as collateral and the resale only permitted for resellers in the customary course of business and only under the condition that the reseller receives a payment from his customer or stipulates the reservation that the property shall only pass to the customer when he has satisfied his payment obligations.
3. In case of attachments, seizures or other disposals or interventions of third parties the buyer has to inform us immediately so that we can file an action according to Section 771 ZPO [German Code of Civil Procedure]. Insofar as the third party is not in the position to reimburse us the court and out-of-court costs of an action according to Section 771 ZPO, the buyer will be liable for the loss incurred to us.
4. The buyer undertakes to treat the object of purchase with due care and attention; he is in particular obliged to sufficiently insure these at the value as new at his own costs against damages caused by fire, water and theft. Insofar as maintenance and inspection work is necessary the buyer must carry this out in time at his own costs.



# General Terms of Sale and Delivery

5. In case of breaches of duty by the buyer, in particular with default of payment we are entitled to cancellation and to take the goods back; the buyer is obliged to hand the goods over. The taking back of goods respectively the assertion of the reservation of title does not require any cancellation of the supplier; these acts or an attachment of the reserved goods by us shall not represent a cancellation of the contract unless we had explicitly declared this.

6. If the buyer has resold the object of purchase in the ordinary course of business then he shall hereby now already assign all claims to us in the amount of the final invoice amount (including value added tax) of our claim, to which he is entitled from the resale against his buyers or third parties, irrespective of whether the object of purchase has been resold without or after processing. The buyer shall also remain authorized to collect this claim after the assignment. Our authorization to collect the claim ourselves shall remain unaffected hereby. However, we undertake not to collect the claim as long as the buyer satisfies his payment obligations from the collected proceedings, is not in default of payment and in particular no application has been filed for the opening of insolvency proceedings or payments have been suspended. If this is however the case we can request that the buyer announces the assigned claims and their debtors to us, provides us all details which are necessary for the collection, hands over the associated documents and informs the debtors (third parties) of the assignment.

7. The processing or conversion of the object of purchase by the buyer is always carried out on our behalf. If the object of purchase is processed with other objects, which do not belong to us, then we shall acquire the co-ownership to the new object in the ratio of the value of the object of purchase (end invoice amount, including value added tax) to the other processed objects at the time of the processing. Incidentally, the same shall apply to the object produced by processing as to the object of purchase delivered under reservation.

8. If the object of purchase is inseparably mixed with other objects that do not belong to us then we shall acquire the co-ownership to the new object in the ratio of the value of the object of purchase (end invoice amount, including value added tax) to the other mixed objects at the time of the mixing. If the mixing is carried out to the extent that the object of the buyer is to be seen as the main object then it shall be deemed as agreed that the buyer assigns us the pro rata co-ownership. The buyer shall store the thus produced sole ownership or co-ownership on our behalf.

## § 8 Quality defects

We shall be liable for quality defects as follows:

1. All those parts or services are to be subsequently improved free of charge at our choice, delivered or provided new, which – irrespective of the operating duration – feature a quality defect if this cause existed already at the time when the risk was passed.
2. Claims for quality defects shall become statute-barred in 12 months. The deadline will begin with the passing of the risk (Subclause 6).
3. The buyer has to report quality defects to us immediately in writing.
4. In case of reports of defects payments of the buyer may be withheld in a scope, which is in reasonable relation to the occurred quality defects. If the defect is unjustifiably reported we are entitled to request reimbursement of the expenses incurred to us by the buyer.
5. We are first of all always to be granted the opportunity for the subsequent fulfillment within a reasonable period of time.
6. If the subsequent fulfillment fails the buyer can – irrespective of possible claims for damages – cancel the contract or reduce the remuneration. The buyer can only request reimbursement for fruitless expenses if we are responsible for the defect owing to wilful intent or gross negligence.
7. Defects shall not exist with an only insignificant deviation from the agreed conditions, with an only insignificant impairment to the usability, with natural wear and tear or damages, which are caused after the risk has passed as a result of faulty or negligent treatment, excessive use, unsuitable operating equipment or owing to special external influences, which are not presumed according to the contract, as well as with software faults that cannot be reproduced. If improper changes or repair work is carried out by the buyer or by third parties then this and the thus incurred consequences shall not substantiate any defects either. The same shall apply if our stipulations concerning the handling and other instructions are not complied with and a proper maintenance is not carried out.
8. Claims of the buyer owing to the expenses, which are necessary for the purpose of the subsequent fulfillment, in particular transport, route, labour and material costs, are excluded if the expenses increase, because the object of the delivery has subsequently been taken to another location than the buyer's branch unless the transportation corresponds with its use as intended.
9. Statutory claims for recourse of the buyer against us shall only exist to the extent that the buyer has not reached any agreements with its buyer that go beyond the statutory claims for defects.
10. Subclause 9 shall apply to claims for damages. Further or other than claims regulated in this Subclause or in Subclause 9 owing to a quality defect are excluded.

## § 9 Industrial property rights and copyrights, defects of title

Insofar as not otherwise agreed, we are obliged to merely provide the delivery in the country of the place of delivery free of industrial property rights and copyrights of third parties (hereinafter property rights). Insofar as a third party asserts justified claims owing to the infringement of property rights due to deliveries provided by us and used as per contract against the buyer, we shall be liable towards the buyer as follows within the deadline determined in Subclause 8.2:

1. We will, at our choice and at our costs, either obtain a right of use for the deliveries concerned, change these so that the property right is not infringed, or exchange these. If this is not possible for us at reasonable conditions, the buyer shall be entitled to the statutory rights to cancellation or reduction. The buyer can only request reimbursement for fruitless expenses if we are responsible for wilful intent or gross negligence. Our obligation to pay compensation is oriented to Subclause 10.
2. The afore-mentioned obligations shall only exist if the buyer informs us immediately in writing about the claims asserted by third parties, does not recognise an infringement and we reserve the right to all defence measures and settlement negotiations. If the buyer discontinues the use of the delivery for reasons to minimise damages or for other important reasons he undertakes to inform the third party that the discontinuation of the use is not associated with a recognition of an infringement of a property right.
3. Claims of the buyer are excluded insofar as he is responsible for the infringement of property right.

4. Claims of the buyer are further excluded insofar as the infringement of property right is

caused by special stipulations of the buyer, due to an application that is not foreseeable for us or by the fact that the delivery is changed by the buyer or is used together with products not delivered by us.

5. In the event of infringements of property rights the provisions of Subclauses 8.4, 8.5 and 8.9 shall apply accordingly to the claims of the buyer regulated in Subclause 13.

6. Further or other claims of the buyer against us or our vicarious agents owing to a defect of title than those regulated in this Subclause 9 are excluded.

## § 10 Joint and several liability

1. Claims of the buyer for damages – irrespective of the legal nature of the asserted claim – are excluded.
2. Excluded from this are:
  - a) Damages owing to the breach of essential contractual obligations. Deemed as essential are such contractual obligations, the fulfillment of which makes the proper execution of the contract possible at all and on the compliance with which the contractual partner may as a rule rely and depend on.
  - b) Damages from the injury to life, the body or the health if we are responsible for the breach of obligation.
  - c) For other damages, which are due to a wilful or grossly negligent breach of duty, whereby our breach of duty is deemed equivalent to that of our legal representatives or vicarious agents.
  - d) Liability according to the ProdHaftG (German Product Liability Act)
3. A change to the burden of proof for the disadvantage of the buyer is not associated with the afore-mentioned regulations.
4. Insofar as the liability for damages is excluded or limited against us, this shall also apply with regard to the personal liability for damages of our employees, our commercial agents and our vicarious agents.

## § 11 Obligations of the buyer to provide assistance

1. Assistance services of the buyer, which are explicitly or tacitly agreed within the framework of the contract, shall be carried out without a special remuneration unless explicitly otherwise agreed.
2. The buyer is obliged to inform us about all facts in time, from which it can be derived that goods and products in stock in our company, which we have made available with regard to the production capacities reported to us, cannot be used or not used in full. If residual stocks remain the buyer shall take over the stocks and the, if applicable incurred destruction costs in the event of a premature change to its material scheduling. This shall also apply to products, with which we had to order minimum quantities on the part of our suppliers if we have informed the customer hereof in advance.
3. The buyer guarantees that the products supplied by him for processing are suitable for this purpose. We are not obliged to examine the products supplied by the buyer for the condition and the suitability for the further processing. Within the framework of ongoing business relationships as well as if an object for processing has initially been inspected, tested and released, the buyer undertakes to inform us of each product change without request in writing. In the case of regular processing of objects the buyer is further obliged to examine the object that is to be processed by us for deviations and changes for each change to the production conditions and in his company, in particular with the exchange of tools, machines or with the introduction of new production processes and to notify us of such changes and modifications in writing.
4. We do not have to examine the instructions of our buyers, the material selection or other regulations, which are made by our buyer, for their accuracy.
5. Therefore, the buyer has to examine all instructions, which he issues as well as the quality of the materials stipulated or made available to us for the compliance with the statutory and technical regulations.
6. If the buyer is in default with regard to his obligation for provision or to provide assistance after a written warning we are entitled to the statutory rights.
7. Goods may only be returned with the supplier's express permission. Any returned goods must be delivered free in their original packaging and must be accompanied by the return receipt provided by the supplier. The goods must be in their original state, i.e. undamaged and fully functional. Returned goods will no longer be accepted when six months have lapsed from the date of delivery. Returns of specially designed or custom-made items, as well as used goods will not be accepted. We will charge a handling fee of 20 % - 40 % of the value of the goods, however, at least EUR 100 per item plus statutory VAT. Following presentation of appropriate evidence, the supplier reserves the right to charge a higher amount to the purchaser in individual cases; the purchaser is free to prove that the damage was lower.

## § 12 Place of performance and place of jurisdiction/miscellaneous

1. The place of performance and place of payment is the registered seat of our company in Sontheim/Brenz.
2. The law of the Federal Republic of Germany is to be exclusively applied to the contractual relationship. The application of the Convention of the United Nations of 11 April 1980 concerning Contracts for the International Sale of Goods (CISG „Law governing the sale of goods of Vienna“) is excluded.
3. With all disputes ensuing from the contractual relationship, if the orderer is a merchant, a legal entity under public law or a special fund under public law, the action is to be filed at the court that has jurisdiction for our headquarters. We are also entitled to file action at the headquarters of the orderer.
4. We store your data according to Section23 Federal Data Protection Act.

**RÖHM GmbH**  
**89565 Sontheim (Germany)**

**Status: November 2021**

# General Service Terms (ASB) of RÖHM GmbH, Sontheim

## 1. Validity

1.1 These ASB form the basis for all business transactions with our customers, which refer to the repair or maintenance of the products manufactured or delivered by us insofar as these customers concern entrepreneurs within the meaning of Section 14 BGB [German Civil Code].

1.2 Contradictory, supplementary contractual terms and conditions of the customer or those which deviate from these ASB will not be recognised.

1.3 Within the framework of a regular business relationship these ASB will also be valid after the effective inclusion for the first time if we do not explicitly refer hereto in follow-up transactions.

1.4 Insofar as the ASB do not include any regulations, the General Terms of Sale and Delivery of RÖHM GmbH shall apply.

## 2. Offer and conclusion of the contract

2.1 Our offers are – insofar as not explicitly marked as binding – without obligation and merely to be understood as invitatio ad offerendum. The right is reserved to an interim sale.

2.2 Contracts with us will only be concluded with our written acceptance declaration or – if such is not carried out – by our delivery and service. Changes and supplementations to the contracts concluded with us require a written form.

2.3 If the object of maintenance or repair was not delivered by us then the customer has to point out existing industrial property rights with regard to the object if we are not responsible for any fault the customer shall indemnify us from possible claims of third parties from industrial property rights.

2.4 Insofar as we are responsible for negligence Par. 2.3 shall apply accordingly.

## 3. Contractual parts

The offer and the product list respectively available to us and the customer are a part of the contract.

## 4. Technical documents and plans

4.1 All rights to our offer documents as well as documents, which have been handed over, shall remain reserved.

4.2 The customer shall recognise our rights and will not reproduce the documents in full or in part, not make these accessible to third parties or use these for any other purpose than that for which they were handed over to him without our prior written authorization.

## 5. Scope of services, maintenance, condition of device, repair

5.1 Decisive for the scope of our delivery and service is our binding offer or – if such is not available – our written declaration of acceptance. Both individual services can be agreed, which are principally to be remunerated according to Subclause 12.1, as well as the service packages described under Subclause 5.2, which are to be remunerated according to 12.2 respectively 12.3.

5.2 The following activities are a part of our service obligation with the processing of service packages:

### 5.2.1 Commissioning of service

- skilled execution of the necessary commissioning of the clamping device and control at the place of installation in line with the regulations of the manufacturer.
- assembly work over the course of the commissioning together with the machine manufacturer
- first instructions and operator training
- we will invoice separate requests for the training with regard to the maintenance and use as separate work.

### 5.2.2 Inspection service

Skilled execution of the necessary inspection of the clamping device and control at the place of installation in line with the regulations of the manufacturer. Insofar as additional maintenance or repairs become necessary at the customer's request or owing to special loads, these are to be remunerated separately by the customer.

### 5.2.3 Maintenance service

Skilled execution of the necessary maintenance of the clamping device and control at the place of installation in line with the regulations of the manufacturer. Insofar as additional repairs become necessary at the customer's request or owing to special loads, these are to be remunerated separately by the customer.

5.3 The service obligation shall begin with the purchase or conclusion of a service package. With the purchase or conclusion of a service package after the expiry of the warranty period the service obligation of RÖHM shall only refer to such products, which are capable of use and free of defects at the time of the conclusion or purchase of the service package. This is to be ensured by an inspection of the products; if defects are determined these are to be remedied before the start of validity of the service package by a necessary repair liable to costs; this repair is not part of the service package.

5.4 Our service obligation shall not include carrying out work on products and accessories, which was(were) not delivered by us.

5.5 Our service obligation shall lapse if the product was not subjected to the function and safety tests according to the details in the operating instructions or third parties have carried out work on the products concerned without our prior written consent unless this work has no disadvantageous influence on the provision of our service. The same shall apply if the products have been damaged due to causes for which we are not responsible, for example by water, fire, stroke of lightning or other implications of force majeure as well as with improper treatment by the customer or third parties.

5.6 Depending on the use and type of the product an overhaul may be necessary after longer use. This is the case if the costs of a repair exceed the current value of the product. Overhaul within this meaning is also the necessary new acquisition of a product in the absence of available spare parts. Overhauls are not part of the service obligation within the service packages. If we are of the opinion that a product that is to be maintained by us under a service package requires an overhaul, we will inform the customer hereof by stating the current value estimated by us and submit an offer for the overhaul to the customer with a remuneration calculated according to 12.1.

## 6. Repair/service that cannot be carried out

6.1 The services provided concerning the details of a cost estimate as well as the further incurred and to be proven work (fault search time equal to working hours) will be invoiced to the customer if the repair cannot be carried out due to reasons for which RÖHM GmbH is not responsible, in particular because the fault for which a complaint will be made did not occur during the inspection, spare parts cannot be procured, the customer culpably missed the agreed date or the contract was terminated during the execution.

6.2 The object of repair only needs to be restored to the original condition again at the explicit request of the customer against reimbursement of the costs unless the undertaken work was not necessary.

6.3 In case of a repair that cannot be carried out RÖHM GmbH shall not be liable subject to sentence 2 for damages to the object of repair, the breach of contractual secondary obligations and for damages, which were not suffered to the object of repair itself, no matter to which legal grounds the customer refers. RÖHM, on the other hand, will be liable in case of wilful intent, with gross negligence of the owner / the executive bodies or executives as well as with the culpable breach of essential contractual duties. Such contractual obligations are deemed essential, the fulfilment of which makes the proper execution of the contract possible at all and the compliance with which the contractual partner may as a rule rely and depend upon.

## 7. Duration of the service

7.1 The details with regard to the duration of repairs and services are based upon estimates and merely serve as information and a first estimate by the customer. They are therefore not binding if they have not been explicitly marked as binding.

7.2 In case of subsequently placed additional and extension orders or with necessary additional repair work the agreed repair deadline shall be extended accordingly.

## 8. Obligations to provide assistance of the customer

8.1 The customer has to draw our attention to the statutory, official and company safety and other regulations applicable at the place of destination of our delivery and service, which refer to the delivery, the assembly and the operation.

8.2 The customer will inform us with or immediately after his order about possible special features of the place of installation, which may have an implication on the proper function of the products, in particular about the structural condition and the concrete operating environment.

8.3 The customer shall ensure – also during the warranty period according to Subclause 17.5 – a regular and skilled maintenance of the products delivered by us insofar as this was not taken over by us as per contract.

8.4 The customer shall dispose of the goods delivered by us at his own responsibility and at his own costs according to the respective valid regulations. We are not obliged to create a possibility for the return unless this would have been stipulated by law.

8.5 The customer has to support the repair / maintenance personnel with the execution of the repair at his own costs.

8.6 The customer has to take the special measures, which are necessary for the protection of persons and objects at the workplace. He also has to inform the repair managers about existing special safety regulations insofar as these are of significance for the repair personnel. He shall inform us in case of breaches of the repair personnel of such safety regulations. In case of serious breaches he can refuse the infringing party access to the repair location by mutual agreement with the repair manager.

8.7 The customer shall bear a supervisory and assistance obligation for the compliance with the statutory working time limits. Breaches are to be reported to RÖHM GmbH.

8.8 The customer is obliged to provide the reasonable and necessary technical assistance at his costs, in particular to:

- a) Provision of the necessary, suitable assistants in the number that is necessary for the repair and for the necessary time; the assistants have to follow the instructions of the repair manager. We do not assume any liability for the assistants. If a defect or damages were caused by the assistants owing to instructions of the repair manager, then the regulations of Sections 17 and 18 shall apply accordingly.
- b) Undertaking of all construction, bedding and scaffolding work including the procurement of the necessary building materials.
- c) Provision of the necessary devices and heavy tools as well as the necessary commodities and required materials.
- d) Provision of heating, lighting, operating power, water, including the necessary connections.
- e) Provision of necessary, dry rooms, which can be locked for the storage of the tool for the repair personnel.
- f) Protection of the repair place and materials against harmful influences of all kinds, cleaning of the repair place.
- g) Provision of suitable, theft-proof recreation rooms and work rooms (with heating, lighting, washing possibility, sanitary facilities) and First Aid for the repair personnel.
- h) Provision of the materials and undertaking of all other acts, which are necessary for the adjustment of the object of repair and for carrying out a testing that is envisaged as per contract.

8.9 The technical assistance of the orderer must guarantee that the service can be started immediately after the arrival of our personnel and carried out without delay until the acceptance by the orderer. Insofar as special plans or instructions of RÖHM are necessary, RÖHM shall make these available to the orderer in time.

## 9. Obligations of the customer to provide assistance in case of maintenance

9.1 The products are to be used as intended and according to their protection type and in line with the operating instructions together with their annexes.

9.2 In case of an agreement of one of the service packages described in Subclause 5, the customer will place the products that are to be installed, maintained or repaired into a faultless condition, capable of use before conclusion of the contract at his own costs if the products are not already in such a condition. If the customer does not properly satisfy this obligation either after a warning on our part and within the deadline we are entitled to accordingly cancel the contract or the delivery. Further claims for damages on our part shall remain unaffected.

9.3 If the customer uses the maintenance service interferences are to be reported to us immediately in writing, in detail and in an understandable manner.

9.4 Our employees and vicarious agents are to be granted the unimpeded and safe access to the products. In case of delays for which the customer is responsible he is obliged to remunerate the waiting times of our employees and vicarious agents resulting from the delay separately.

9.5 The customer shall refrain from commission third parties with the services during the term of a service agreement, which we have to provide according to the agreement or from performing this work himself.

9.6 The customer has to draw our attention to the statutory, official and company safety regulations and other regulations applicable at the place of destination of our delivery and service, which refer to the delivery, the assembly and the operation.

## 10. Inspection and acceptance

10.1 Services will be provided by us according to the guidelines of our quality control and deliveries inspected accordingly. If the customer requests further inspections then these are to be agreed in writing and paid by the customer. This shall relate e.g. to special tests for the acceptance.



# General Service Terms (ASB) of RÖHM GmbH, Sontheim

10.2 The customer undertakes to accept our services under this contract immediately after the report that they have been completed. Upon request he has to declare their acceptance in writing towards our employees or vicarious agents insofar as there is no essential defect. This is carried out by the signing of the service report.

10.3 Our services shall be deemed as accepted free of defects with the re-commencement of the operational use of the maintained or repaired product, in particular for production purposes, if no defects have been previously reported by the customer.

## 11. Cost details and cost estimate

11.1 The creation of the cost estimates is liable to costs if the execution of the repair is not approved.

11.2 The costs for a cost estimate amount to the flat rates fixed in the current price list.

11.3 If the repair cannot be carried out at these costs or if our employees or vicarious agents consider the execution of additional work to be necessary during the repair the customer's consent is to be obtained if the stated costs are exceeded by more than 15%.

## 12. Remuneration, maturity and terms of payment

12.1 Insofar as not otherwise agreed and there is no warranty case our services are to be remunerated according to the actual work requirement pursuant to our respectively valid general price lists. The time required by our employees will be settled in time sections of 15 min. In addition to the time required for the work that is to be performed in these cases the customer will pay the travelling and waiting times, overtime surcharges, expenses, travelling and accommodation costs as well as the costs of spare parts, materials subject to wear and tear and consumables and replacement part sets according to our prices lists or in line with the offer.

12.2 Insofar as a flat rate remuneration was agreed for a service package, our work and travelling costs and expenses are thus covered, not however the costs for waiting times, overtime at the customer's request, spare parts, materials subject to wear and tear and consumables, replacement parts sets as well as other accessories. Our work for if applicable necessary repairs is to be remunerated separately by the customer according to Subclause 12.1.

12.3 The prices for our services can be derived from the respective price list valid upon conclusion of the contract and are deemed ex works plus value added tax. The calculation basis for the remuneration is the one-shift operation, i.e. a use of the products up to 160 hours in a calendar month. A surcharge to the list price of 50% is charged for the two-shift operation, a surcharge of 100% for the three-shift operation. The above two rates shall only apply to the service packages described under Subclause 5.. If the customer requests assignments outside of our normal working hours (Mo - Fr, 6:30 am - 6:30 pm, a max. of 7 h per day) surcharges will be calculated according to the respective valid price list.

12.4 If our personnel and material costs are increased then we are entitled to adjust the contractual prices after the expiry of the first year up to a maximum of 5% above the price of the previous year. Price changes will be announced to the customer at least one month before the new contractual prices come into force. The customer is entitled to terminate the contract effective as of the time at which the new price would become valid for him for the first time.

## 13. Transport and insurance with the repair in the plant of RÖHM GmbH

13.1 The object for repair will be delivered by the customer to us at his costs together with the repair and service form and after execution of the repair collected by the customer again or return to him at the customer's costs.

13.2 The customer shall bear the risk of transport.

13.3 At the customer's request a shipment carried out by us will be insured at the customer's costs against the insurable transport risks, e.g. theft, breakage and fire.

13.4 No insurance cover exists during the repair time in our plant. The customer has to ensure the maintenance of the existing insurance cover for the object of repair e.g. with regard to fire, pipe water, storm and machine breakage insurance. Insurance cover can only be procured for these risks at the explicit wish and costs of the customer.

13.5 In case of delay of the customer with the take-over we can charge a storage fee for the storage in our plant. The object of repair can also be stored otherwise at our discretion. The costs and risk of the storage during the delay shall be for the expense of the customer.

## 14. Repair deadline

14.1. The details concerning the repair deadlines are based on estimates and merely serve for the purpose of information and first orientation. They are therefore not binding unless this is explicitly agreed.

14.2. The agreement of a binding repair deadline, which must be described as binding, can only be requested by the customer if the scope of the work has been precisely determined.

14.3. The binding repair deadline will have been adhered to if by the time that it expires the object of repair is ready for take-over by the customer, in the event of a contractually envisaged testing ready for its execution.

14.4. In case of subsequently placed additional and extension orders or with necessary additional repair work the agreed repair deadline will be extended accordingly.

14.5. If the repair is delayed due to measures within the scope of industrial disputes, in particular strike and lock-out as well as the occurrence of circumstances, which were not caused by us, a reasonable extension to the repair deadline will occur insofar as such impediments have as proven a substantial influence on the completion of the repair; this shall also apply if such circumstances occur after we are in default.

## 15. Ban on offsetting and assignment; subcontractors

15.1 The customer is only entitled to offsetting in the event of undisputed claims or claims which have been declared final and binding. This shall not apply if the customer asserts claims in the reciprocal relationship, in particular claims for defects.

15.2 The assignment of rights of the customer from contractual relationships with us presumes our prior consent in order to be valid. This shall not apply insofar as Section 354 a HGB [German Commercial Code] applies.

15.3 We are entitled to use third parties in order to fulfil our contractual obligations.

## 16. Reservation of title

16.1 The goods delivered by us shall remain our property until the payment of all of our claims against the customer, no matter for what legal grounds, also future ones. In case of current account the afore-mentioned property shall be deemed as security for our balance claim.

16.2 The customer may only sell within the framework of his customary business transactions and neither pledge, nor assign the goods as collateral. The customer hereby

assigns us for security of our payment claims against him, in the amount of the value of our delivery and service, all claims with all secondary rights, which he acquires against his buyer owing to such a sale.

16.3 As long as the property has not yet been assigned, the customer has to inform us immediately in writing if the delivered object is attached or is exposed to other interventions of third parties. Insofar as the third party is not in the position to reimburse us the court and out-of-court costs of an action according to Section 771 ZPO [German Code of Civil Procedure] the customer shall be liable for the loss incurred to us.

16.4. We undertake to release the securities to which we are entitled at the customer's request insofar as their value exceeds the claims which are to be secured by more than 20 %."

## 17. Warranty

17.1 Insofar as the creation of a work has been agreed and thus the law governing contracts for work and services applies the following shall apply: If our services are faulty then we are first of all entitled and obliged to subsequent satisfaction according to Section 634 No. 1 BGB. If the subsequent satisfaction finally fails the customer can according to Section 634 No. 3 cancel the contract or reduce the remuneration and according to Section 634 No. 4 BGB request damages. Claims of the customer for reimbursement of expenses according to Section 634 No. 2 BGB (self-execution) are excluded. Subclause 18 shall apply to claims for damages.

17.2 Insofar as we provide planning services without executing these and thus the law governing service contracts applies (e.g. in the event of a breach of our duties under Subclauses 5.2.1, 5.2.2 and 5.2.3) the following applies: If our services are faulty then we are first of all entitled and obliged to subsequent improvement. If the subsequent improvement finally fails the customer is entitled to damages according to Subclause 18.

17.3 Excluded from the warranty are damages as a result of natural wear and tear, faulty maintenance – insofar as we have not carried out this maintenance as per contract, failure to comply with operating equipment regulations, excessive use, unsuitable operating equipment, chemical or electrolytic influences, faulty construction and assembly work of third parties as well as other causes, for which we are not responsible.

17.4 The warranty shall lapse if the customer or third party makes changes or repairs to our services /products without our prior written consent unless the defect is not a result thereof.

17.5 Claims of the customer owing to defects of quality and title shall become statute-barred with the expiry of 12 months after the acceptance of the work or the knowledge of defects with the provision of planning services.

## 18. Liability

18.1 We shall be liable to an unlimited extent in case of wilful intent and gross negligence as well as with the injury to life, the body and the health as well as with the culpable breach of essential contractual obligations. Deemed as essential are such contractual obligations, the fulfilment of which makes the proper execution of the contract possible at all and the compliance with which the contractual partner may as a rule rely and depend on.

18.3 Incidentally our liability is excluded.

18.4 A liability according to the Product Liability Act remains unaffected.

18.5 The personal liability of our legal representatives and vicarious agents is limited as our own liability according to the afore-mentioned provisions.

## 19. Term of the contract; termination

19.1 Service agreements according to Subclause 5. shall come into force when signed by both parties and shall initially apply until the end of the calendar year, that follows the year in which the contract was concluded. The contractual relationship will subsequently be extended respectively by one further year unless it is terminated by one of the parties with a period of notice of 3 months to the end of the second or a following year. Contractual relationships can be terminated on the whole or only with regard to individual products.

19.2 The right to the extraordinary termination for an important reason remains unaffected.

## 20. Place of jurisdiction; applicable law

20.1 With all disputes ensuing from the contractual relationship if the orderer is a merchant, a legal entity under public law or a special fund under public law, the action is to be filed at the court that has jurisdiction for our headquarters. We are also entitled to file an action at the headquarters of the orderer.

20.2 The legal relationship is subject to the law of the Federal Republic of Germany. German international private law and the Viennese Convention of the United Nations concerning Contracts for the International Sale of Goods (CISG) will not apply.

RÖHM GmbH

89565 Sontheim (Germany)

Status: October 2015

**RÖHM GmbH**

Heinrich-Röhm-Straße 50

89567 Sontheim/Brenz

Germany

Tel +49 7325 16 0

Fax +49 7325 16 510

info@roehm.biz

www.roehm.biz



Item no. 1178262 / 0124 AU